

NOAA Technical Memorandum ERL PMEL-88

THE SEA ICE MARGINS: A SUMMARY OF PHYSICAL PHENOMENA

Robin D. Muench

Pacific Marine Environmental Laboratory
Seattle, Washington
May 1989



**UNITED STATES
DEPARTMENT OF COMMERCE**

**Robert A. Mosbacher
Secretary**

**NATIONAL OCEANIC AND
ATMOSPHERIC ADMINISTRATION**

**William E. Evans
Under Secretary for Oceans
and Atmosphere/Administrator**

**Environmental Research
Laboratories**

**Joseph O. Fletcher
Director**

NOTICE

Mention of a commercial company or product does not constitute an endorsement by NOAA/ERL. Use of information from this publication concerning proprietary products or the tests of such products for publicity or advertising purposes is not authorized.

Contribution No. 1049 from NOAA/Pacific Marine Environmental Laboratory

For sale by the National Technical Information Service, 5285 Port Royal Road
Springfield, VA 22161

FORWARD

We at the Pacific Marine Environmental Laboratory are pleased to publish this report on sea ice margins in our Technical Memorandum Series. Dr. Muench's manuscript is an important summary, which contrasts processes occurring in different marginal ice zones. Each NOAA Technical Memorandum is assigned a National Technical Information Service number and can be cited in journal publications with that number, typically available six months after publication.

James Overland
Carol Pease
Marine Services Research Division
January 1989

PREFACE

This report was initially drafted during Autumn 1986 while the author was a Visiting Scholar at the Scott Polar Research Institute of Cambridge University, Cambridge, England. It was not conceived of as an exhaustive treatise on physical processes in the marginal ice zones, or as a definitive reference work. It is intended, rather, to be a "broad-brush" portrayal of the phenomena which characterize these dynamic regions and which make them unusual, if not unique, in the World Ocean. It might perhaps be viewed as a "Marginal Ice Zone Primer", comprehensible to the non-physical scientist while at the same time providing a summary for the specialist. It is the author's hope that the information and speculation contained herein will stimulate continued research activities in the marginal ice zones.

Robin D. Muench
July 1988

CONTENTS

PAGE

FORWARDiii
PREFACE	iv
1. INTRODUCTION	1
2. GLOBAL DISTRIBUTION OF THE SEA ICE MARGINS.	3
2.1 The Eastern Arctic Sea Ice Margin	6
2.2 The Western Arctic Sea Ice Margins	10
2.3 The Antarctic Sea Ice Margin	16
2.4 Polynyas	17
3. SMALL SCALE FEATURES AND PROCESSES AT THE ICE MARGINS	20
3.1 Physical Description of Small Scale Features	20
3.2 Stresses at The Ice Margins	25
4. MESOSCALE OCEANIC FEATURES AT THE ICE MARGINS	32
4.1 Fronts and Eddies.	33
4.2 Ice Edge Jets	37
4.3 Ice Edge Upwelling.	39
5. EFFECTS OF THE ICE MARGINS IN MODIFYING WATER MASSES.	40
6. METEOROLOGICAL EFFECTS ASSOCIATED WITH THE ICE MARGINS	44
7. POSTSCRIPT AND ACKNOWLEDGMENTS	47
8. REFERENCES	48

LIST OF FIGURES

1. Schematic of a "typical" sea ice margin.	3
2. Mean monthly sea ice extents for the northern hemisphere during 1973-1976.	4
3. Mean monthly sea ice extents for the southern hemisphere during 1973-1976.	5
4. Schematic of the major ocean currents in the eastern Arctic	8
5. Vertical distributions of temperature and salinity across the East Greenland Current/Polar Front system	9
6. Schematic of the interrelation between northward-flowing warm currents and "meltback embayments" in the Chukchi Sea ice edge	11

7.	Distribution of temperature, salinity, and currents associated with the winter Bering Sea marginal ice zone front12
8.	Number of storms in the western Gulf of Alaska minus those in the Bering Sea, and of ice extent, as functions of year13
9.	Departures from monthly mean ice cover, sea surface temperature and heating degree days for the eastern Bering Sea as functions of year15
10.	Schematic showing pattern of ice movement in the Ross Sea17
11.	Schematic showing the configurations of two polynya areas in the northern Bering Sea19
12.	Transitions in sea ice configuration across the marginal ice zone21
13.	Wind-driven ice divergence computed from the tracks of ice drift buoys in the Greenland Sea marginal ice zone.26
14.	Schematic showing rotation over time of a large ice floe in response to current shear in the Greenland Sea marginal ice zone28
15.	Schematic illustrating the complex mesoscale structure present along the Greenland Sea marginal ice zone34
16.	Schematic illustrating interaction between a cyclonic oceanic eddy and the ice edge in the Greenland Sea35
17.	Schematic showing the spatial relation between complex circulation features as suggested by the ice edge at two different times and complex bottom topography in central Fram Strait.38
18.	Vertical temperature, surface salinity and currents associated with a remnant deep, convective feature in the eastern Weddell Sea.43
19.	Dependence among wind speed, atmospheric mixed-layer height and surface roughness across the marginal ice zone.45
20.	Schematic showing the structure of atmospheric roll vortices, accompanying cloud bands, and underlying sea ice bands which occur commonly at the ice edges when winds are off-ice46

LIST OF TABLES

1.	Relative balance between stresses acting on sea ice in bands in the marginal ice zones, and balance for ice in the pack interior30
2.	Computed first-mode internal wave speed for the Bering Sea and Greenland Sea marginal ice zones32

The Sea Ice Margins: A Summary of Physical Phenomena

Robin D. Muench*

1. INTRODUCTION

The sea ice margins, also referred to commonly as the marginal ice zones (MIZ's), are lateral transition regions between the ice-covered and ice-free portions of the world ocean. These regions are bounded to seaward by the ice edge, outside of which no sea ice occurs. The most commonly used location for the inner boundary of the ice margin is the point where ice divergence, as evidenced by percentage of open water, is not significantly different from that in the interior pack ice well away from the margins. Other definitions can be used within the contexts of specific studies. For example, the inner boundary of the ice margin might also be defined by a location at which propagation of ocean surface waves beneath the ice becomes immeasurably small. In most cases, definitions which differ in their process orientation do not differ greatly in the actual area defined. Some exceptions will be noted below, as appropriate. Actual definitions of the areas included in the ice margins must be provided within a seasonal context, since they vary greatly, seasonally, both in location and in the dominant physical processes. Most of the physical processes which govern sea ice behavior in the interior pack ice regions are also in effect at the ice margins, but their interrelations and relative physical influences can be vastly different at the margins than in the interior. Observed physical conditions at the margins can, consequently, be considerably different from those in the interior pack ice.

The sea ice margins are physically dominated by strong spatial gradients, in the across-margin direction, and by rapid time changes. The spatial gradients are most evident at the sea surface. To seaward lies liquid water, whose minimum permissible temperature is its freezing point, typically about -1.8°C . On the other side of the ice margin lies a floating cover of sea ice, the physical behavior of which is vastly different from that of liquid water. This ice cover has surface temperatures which can vary from the freezing point for freshwater down to several tens of degrees below freezing, depending upon local environmental factors such as the surface air temperature and the amount of insolation. The ice cover has a greater hydrodynamic roughness, due to the presence of ridges and the raised edges of individual floes, than the water. This roughness difference results in a sharp discontinuity across the ice margin in transmittal of wind stress to the underlying ocean. In winter, a very large gradient in sea-air heat flux can occur across the ice margin because the flux of heat from the ocean to the atmosphere is much greater through an open water surface than through an ice cover. The large heat flux near the ice edge can result in rapid freezing there, with consequent release of brine to the underlying water.

* Science Applications International Corporation, 13400B Northup Way, Suite 36, Bellevue, WA 98005

The surface gradients at the ice margins have subsurface counterparts. The margins frequently coincide with oceanic fronts, with higher upper layer water temperatures and higher salinities present seaward of the ice margin than beneath the ice. These fronts can accentuate the surface gradients, comprising, in effect, regions of oceanic temperature and salinity gradient which coincide with the surface gradients in ice properties. These upper layer oceanic frontal structures are strongly interactive with the ice margins; their locations are controlled in part by the presence of the ice margin, while at the same time their presence influences the margin. The warmer water seaward of such a front provides a source of heat for melting of ice. At the same time, the heat taken up by melting cools the water so that the ice can persist out to a "steady-state" ice edge where location is controlled by the balance between ice input and melting. The loss of heat from the water to the melting ice, coupled with the input of low-salinity ice melt water, maintains the oceanic frontal structure. The frontal structures may in turn be affected by wind-driven upwelling, caused by winds blowing across the surface discontinuity in hydrodynamic roughness. Both fronts and upwelling may be associated with local, sometimes quite energetic, ocean current systems which in turn can affect the distribution of ice.

Finally, the surface gradients have their reflection in meteorological processes. The strong lateral gradients in sea-air heat flux at the ice edge can lead to locally strengthened winds. The discontinuity in aerodynamic roughness typically leads to strengthening of atmospheric turbulence, a thickening of the surface mixed layer, and consequent modification to the local wind field. Because the winds strongly influence the mobile ice cover at the margins, these modifications also affect the ice cover in a complex feedback mechanism. Because the ice greatly reduces sea-air heat flux over the open water case, the ice edge tends to limit propagation of cyclonic storms. The heat source needed to maintain the cyclone simply is not present in the ice-covered regions. Hence, cyclones migrating toward the ice margins tend to weaken, or else to change course and parallel the edge. In a converse situation, very cold air moving from the ice-covered regions out across the ice margins can contribute to formation of very severe cyclonic storms called "polar lows".

While it is possible to refer, for a specified geographical region and season, to "mean" sea ice margin locations and conditions, these may bear little resemblance to instantaneous conditions. In fact, the ice margins respond strongly and rapidly to a continuously changing array of external forcing phenomena, the most energetic being cyclonic storms and fluctuations in the underlying ocean currents. In fact, in some areas the "mean" ice distribution can be explained in terms of the frequency with which cyclones traverse the region. As a corollary of these continuously varying instantaneous conditions, the sea ice margins are in general highly non steady-state.

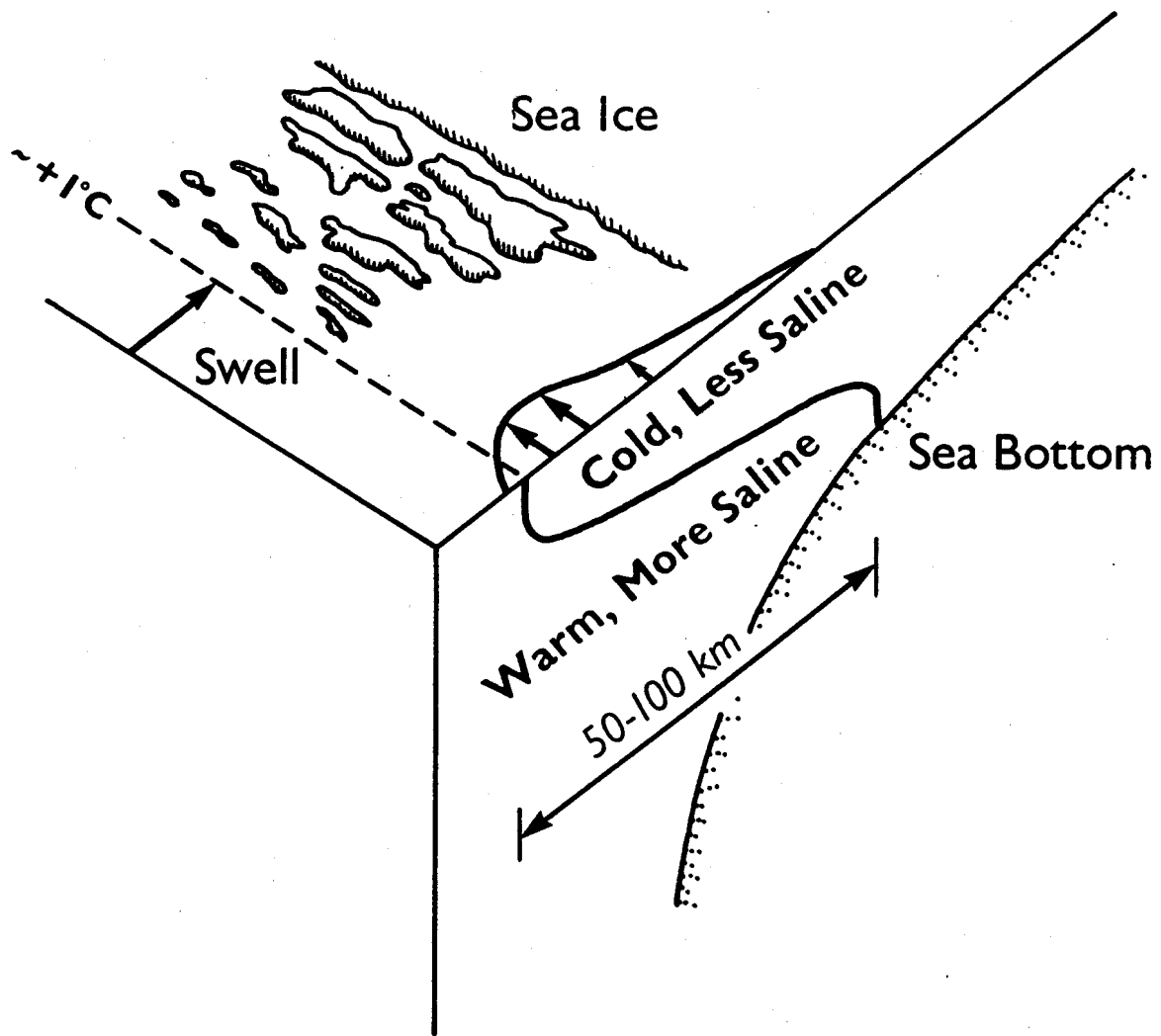

Figure 1. Schematic of a "typical" sea ice margin. A front separates cold, lower salinity water beneath the ice from warmer, more saline water to seaward. The frontal structure results in a current, shown by the arrows contained within a "current profile" curve, which parallels the front and the ice edge. Incoming ocean swell contributes to breaking up ice at the edge.

Figure 1 shows a schematic illustration of a "typical" sea ice margin region as summarized above. The following sections of this report provide more detailed information, both observed and hypothetical, concerning the above points.

2. GLOBAL DISTRIBUTION OF THE SEA ICE MARGINS

The sea ice margins are effectively circumpolar in both the northern and southern hemispheres, and mark the equatorward boundaries of the floating sea ice cover. Figures 2 and 3 show the approximate locations of the northern and southern sea ice margins, including the seasonal variability. The Southern Ocean ice cover has an open equatorward margin which is continuous in winter, extending completely around the Antarctic continent, but which in summer

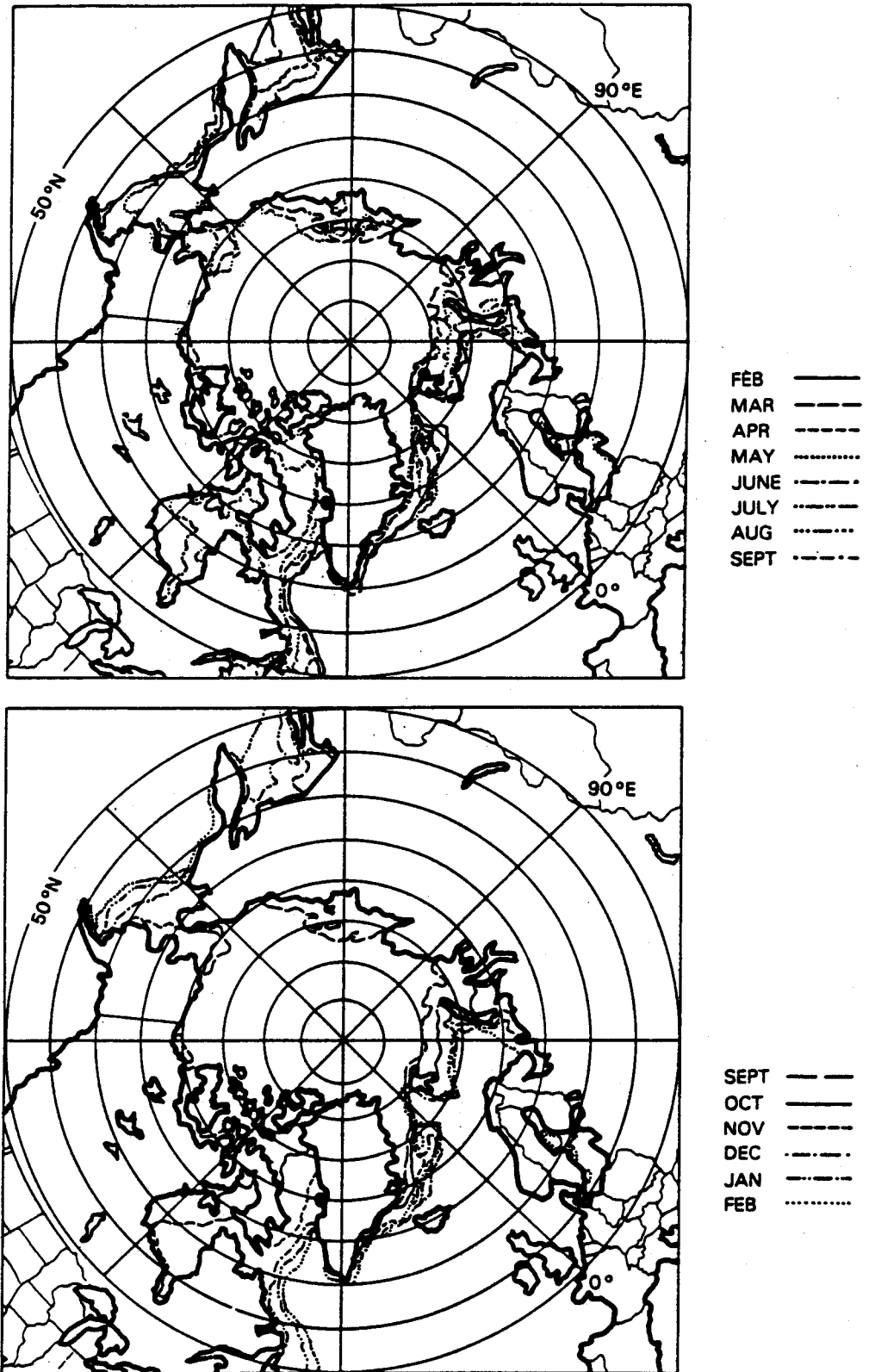

Figure 2. Mean monthly sea ice extents, defined by concentration greater than 15%, for the northern hemisphere during 1973-1976 (from Parkinson *et al.*, 1987). Upper figure shows the ice decay period, while lower figure shows the ice growth period.

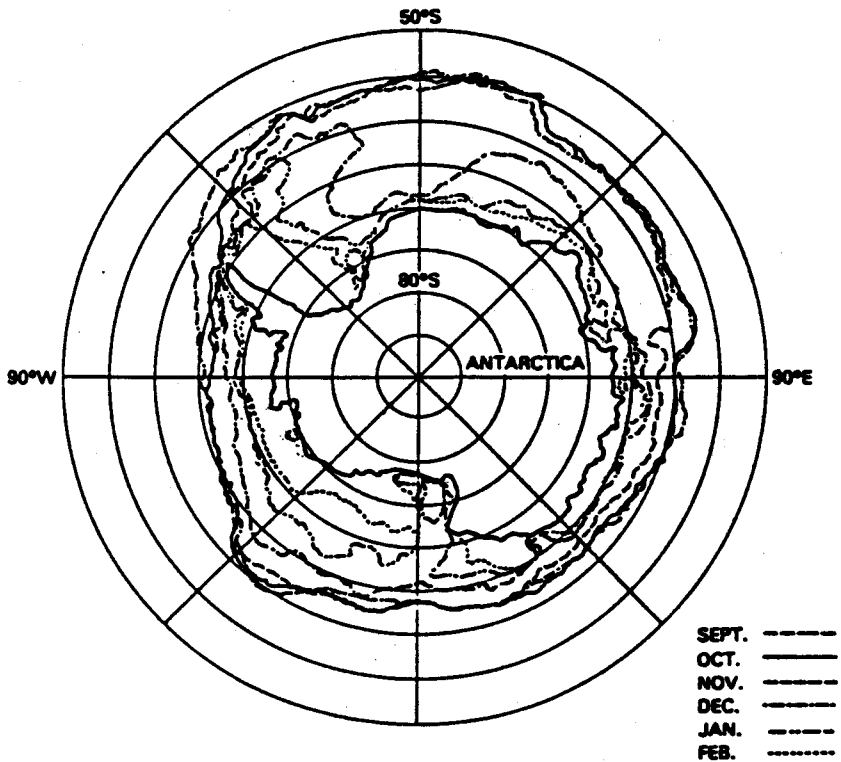
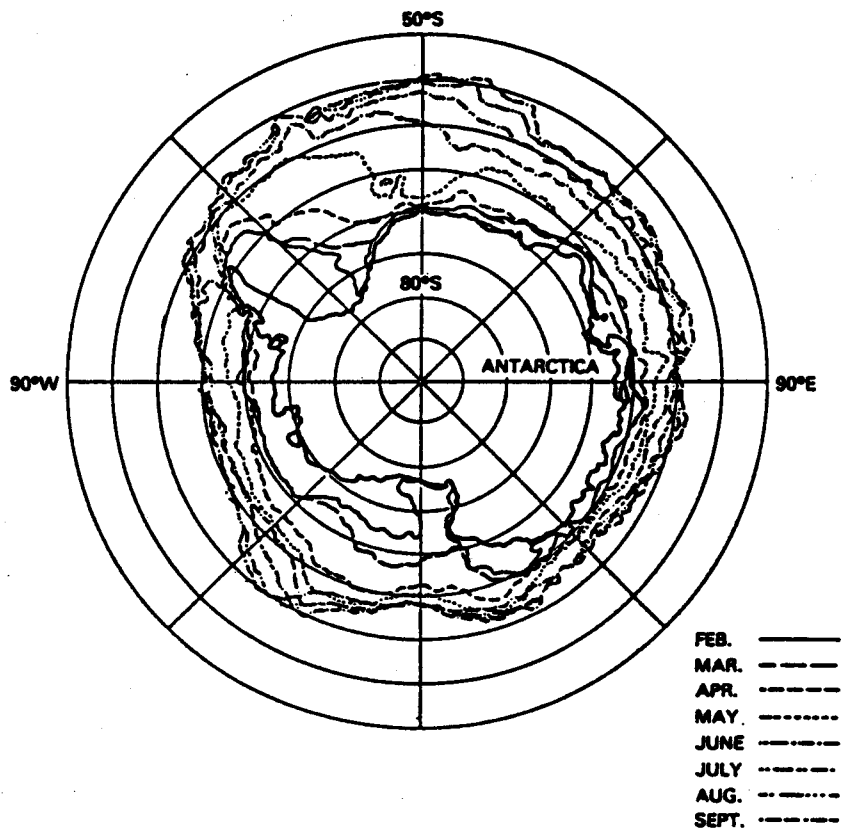

Figure 3. Mean monthly sea ice extents, defined by concentration greater than 15%, for the southern hemisphere during 1973-1976 (from Zwally *et al.*, 1983). Upper figure shows the ice growth period, while lower figure shows the ice decay period.

can be defined only for the Weddell and Ross seas and a few restricted coastal areas. These are the only regions where sea ice persists on a regular basis through the Antarctic summer. The Arctic ice cover has open equatorward margins only in the Bering and Greenland seas during winter, but the open margins extend around a large proportion of the Arctic Basin in summer when the ice cover is at its least extent. These seasonal variations in ice edge location reflect concurrent differences in the balances between physical processes, such as freezing, melting and wind and current drag, at the ice margins. Sea ice, oceanographic and meteorological conditions differ greatly, in general, between winter and summer. It is therefore essential to specify the season when discussing large-scale configuration of the ice margins.

There are well-defined regional differences in the oceanic and meteorological processes which affect the sea ice margins. In the eastern Arctic, the ice margins are influenced primarily by energetic ocean currents, that bring warm ocean water northward from the North Atlantic Ocean and that directly affect the ice margin location through advection. In the western Arctic, the ice margins are influenced strongly by the heat contained in water which flows northward from the North Pacific Ocean to the Arctic Ocean via Bering Strait, and by the time-averaged effects of cyclonic storms which migrate over the region in winter. In the Weddell and Ross seas the summer ice margins are dominated, respectively, by the mean oceanic and atmospheric circulation patterns. In winter, the Antarctic ice margin is controlled primarily by the larger-scale circumpolar oceanic circulation.

The above factors suggest, for discussion purposes, a geographical division of sea ice margins into eastern and western Arctic, and Antarctic. We do not further subdivide the Antarctic, because information on both the ice margins and oceanic processes for areas other than the Weddell Sea is inadequate to justify separate treatments for those areas.

Finally, numerous smaller geographical regions can be identified which exhibit features typifying, especially during winter, the sea ice margins. Most prominent among these features are polynyas, which are regions of open water surrounded by sea ice, when conditions would seem to dictate formation of an ice cover. Polynyas exhibit many of the same physical processes which dominate the sea ice margins on a larger scale, such as extremely large sea-air heat fluxes and rapid formation of new ice. Polynyas are considered important, also, because they are believed to be the sites of large amounts of new ice formation and also areas of generation of dense, brine-enriched seawater that may significantly affect deeper ocean waters.

2.1 The Eastern Arctic Sea Ice Margin

The geographical location of the sea ice margin in the eastern Arctic is indicated on Fig. 2. In winter, the ice margin separates from the northern European coastline somewhere east of Norway, trends westward to the vicinity of Spitzbergen, then lies diagonally in a north-northeasterly direction across the Greenland Sea. It rounds Cape Farewell at the southern tip of

Greenland, forms a northward-extending bight into southern Baffin Bay, then follows offshore of the North American coastline southward to the vicinity of the Gulf of St. Lawrence. In summer, much of this region is ice-free, so that the ice margin extends much farther eastward off the European and Asian arctic coastlines, then falls north-northeasterly across the Greenland Sea to the vicinity of Cape Farewell. Areas to the west and south of Cape Farewell which are ice-covered during winter are ice-free in summer, so that the summer sea ice margin is confined primarily to the Greenland Sea and points farther east in the Arctic Ocean. The sole exception is the ice margin surrounding a small region of multi-year ice which can persist in northern Baffin Bay through the summer. The only region where significant open water is virtually never found is in the Arctic Ocean north of Greenland. This is a consequence of the convergent nature of the ice cover in that location. A large year-to-year variability is superimposed upon these mean locations. For instance, the maximum winter extent of sea ice in the Greenland Sea can vary from a location north of Spitsbergen to one south of Iceland.

The seasonal advance and retreat of the sea ice margin are controlled by interactions between ice melting and freezing. The autumn ice advance occurs when the water column has been cooled to the freezing point and sub-freezing air temperatures persist until ice forms. The spring retreat occurs when combined warm air temperatures, insolation and input of oceanic heat cause ice to melt. The actual ice margin configuration is strongly affected not only by these processes but by the large-scale ocean currents as well (Fig. 4), which both advect heat northward for melting ice and move the ice about.

The major currents in the Greenland Sea are the West Spitsbergen and the East Greenland currents. The former flows northward, past the western Spitsbergen coast in the eastern Greenland Sea and through Fram Strait, bringing with it relatively warm ocean water from the north Atlantic. The northward transport of warm water by this current is responsible in large part for the northward extension of open water, in summer, past Spitsbergen and eastward beyond the Barents Sea. The heat contained in the water contributes energy for melting the ice back during summer, when air temperatures are above freezing. The East Greenland Current flows southward through Fram Strait, initially as a broad, strait-wide flow with a major component entering southwestward from the area north of Spitsbergen. Farther south, this flow occupies only that portion of the Fram Strait-East Greenland Sea region located west of the East Greenland Polar Front, and contains a pronounced high-speed jet-like core which is located just to the west of the front (Paquette *et al.*, 1985). The Polar Front separates cold, low-salinity water exiting the Arctic Basin from the warmer, more saline water of the central Greenland Sea. In summer a north-northeast trending surface front is formed by meltwater from the sea ice. This surface front is located seaward of the deeper, permanent Polar Front, and coincides in summer with the approximate ice edge location. In the region north of Iceland, at about 72-74°N, the winter ice margin forms a major eastward promontory in response to an eastward recirculation in the East

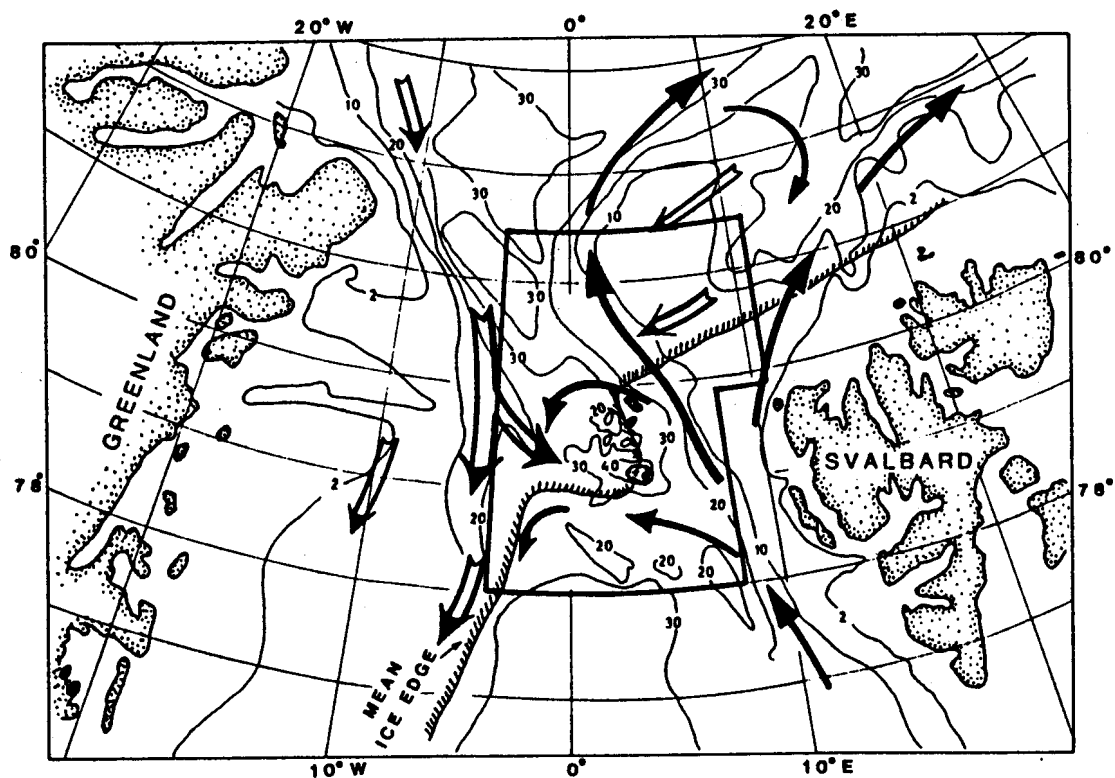

Figure 4. Schematic illustration of the major ocean currents in the eastern Arctic, indicating flow of warm water (solid arrows) and cold water (hollow arrows) (from Johannessen *et al.*, 1987). Hachured line shows the mean summer ice edge location. Depths are indicated in hundreds of meters. Boxed-in region was the location for the summer 1984 Greenland Sea Marginal Ice Zone Experiment.

Greenland Current coinciding, presumably, with an equivalent displacement of the Polar Front. This sea ice promontory is responsible for a large, effective eastward shift in ice edge position in the region.

The East Greenland Polar Front, which forms the approximate eastern boundary of the East Greenland Current, is an effective physical limit to the eastward extent of sea ice in the East Greenland Sea. Water east of the front is well above the freezing point, in contrast to the near-freezing water found west of the front (Fig. 5). Sea ice has been found to melt rapidly when advected into water which is more than a degree C or so above the approximate melting point of the ice. Hence, any ice which might form east of the front, such as during a winter cold air outbreak, or be blown eastward by off-ice winds, is quickly melted by oceanic heat. In summer, this oceanic heat is abetted, in its ice melting role, by incoming solar radiation and by increased air temperatures. Thus, the annual mean distribution is controlled primarily by ocean currents, while the seasonal fluctuations are controlled primarily by the regional climatology.

The East Greenland Current is the major means for transport of sea ice southward out of the Arctic Basin (Vinje and Finnekåsa, 1986). It consists of water which is near the freezing

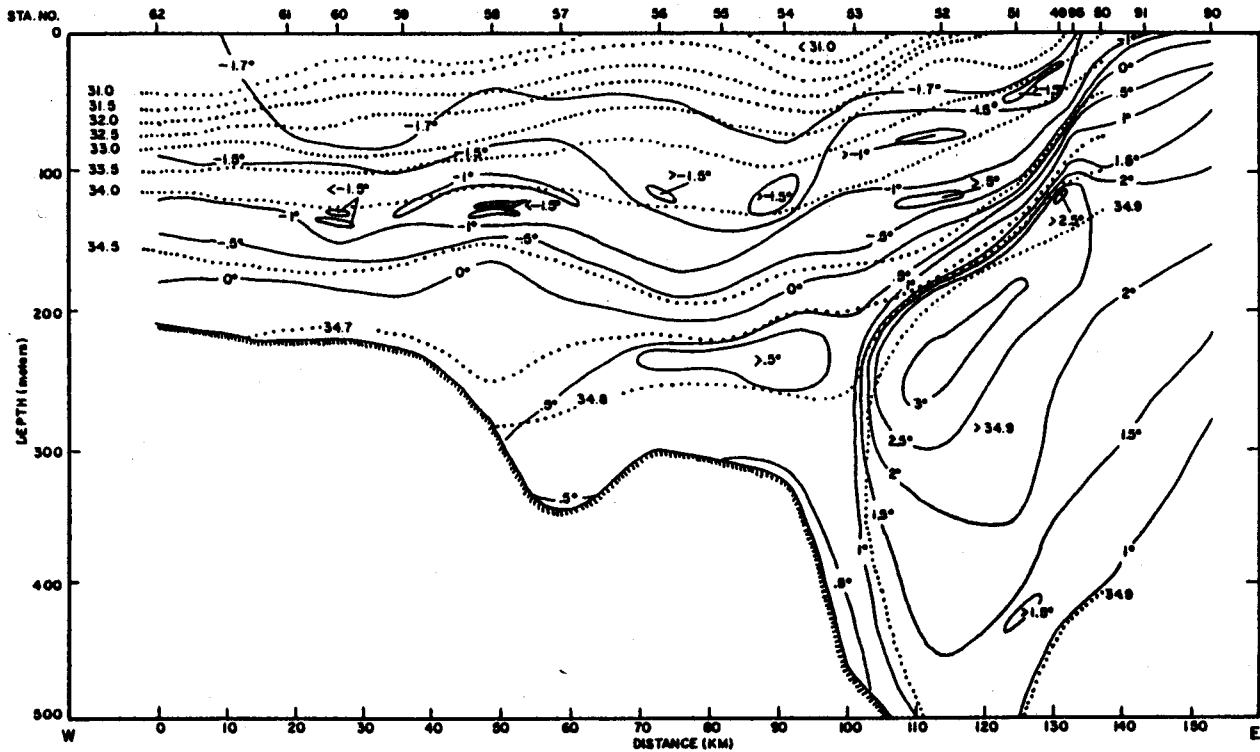

Figure 5. Vertical distributions of temperature (solid contours) and salinity (dotted contours) across the East Greenland Current/Polar Front system at about 78°N (from Paquette and Bourke, 1985).

point, hence, even in summer the overlying ice can persist without melting for as long as several months. This ice survives in the current, in summer, sufficiently long to be advected to at least the vicinity of Cape Farewell. In winter, the eastern Arctic sea ice margins can be traced as a more or less continuous feature from the Greenland Sea, around Cape Farewell, into Davis Strait and down the western coast of North America to the Gulf of St. Lawrence. This edge follows, even after exiting the Greenland Sea, the regional ocean circulation. The winter ice margin in Davis Strait roughly parallels the boundaries of the north-flowing West Greenland Current, then crosses Davis Strait to trend southward along the seaward boundary of the cold, south-flowing Labrador Current. Consistent with the circulation, a large part of this ice is Arctic Ocean ice which has been transported to the ice margins by the East Greenland Current. Progressing toward the west and south, greater and greater proportions of the ice are formed locally along coastal regions and through refreezing in leads. An uncertain amount enters the system via southward advection, from Baffin Bay, by the Baffin and Labrador currents.

2.2 The Western Arctic Sea Ice Margins

The locations of sea ice margins in the western arctic are shown for summer and winter on Figs. 6 and 7, respectively. In mid-winter, when the ice is at its greatest extent, the ice margin is in the vicinity of the continental shelf break in the Bering Sea. In the eastern Bering Sea, the ice margin is well north of the shelf break, however, in the western Bering the ice margin is seaward of the shelf break, with the margin crossing over the shelf break in the central part of the Bering. All areas to the north are ice-covered, with the exception of some coastal polynyas, most notably those in the northern Bering Sea. In mid-summer, the ice margin is in the Chukchi Sea of the Arctic Ocean, some 1000 km north of its winter location, and extends eastward off the Alaskan coastline.

As for the eastern arctic, control over the seasonal mean ice margin location is dominated by the regional ocean circulation. A northward net flow of North Pacific water across the Bering Sea shelf, through Bering Strait and across the Chukchi Sea shelf provides a source of heat which is adequate, in the presence of above-freezing air temperatures, to melt the ice in summer to a location well north into the Arctic Ocean (Fig. 6). The associated volume transport is of order $10^6 \text{ m}^3/\text{s}$. This current bifurcates in the Chukchi Sea, with a portion flowing along the Alaskan coastline toward the east where it results in a coastal band of open water, which varies greatly in width depending upon whether the local winds are on- or offshore. The other branch of the bifurcated current flows northward across the shallow Chukchi shelf where, following depressions in the bathymetry, it selectively melts back "embayments" in the sea ice (Paquette and Bourke, 1981) (Fig. 6). These features provide an excellent example of the degree to which oceanic heat can affect the ice edge configuration.

In winter, the north-flowing Pacific water is cooled during its transit over the relatively shallow Bering Sea shelf nearly to the freezing point; consequently, by the time it has reached the northern portion of this shelf it has virtually no heat left to contribute to ice melting. With no oceanic heat input, and with air temperatures dropping to well below freezing by late November, the ice margin advances rapidly southward from its summer location. The most rapid period of advance normally occurs in December-January, although significant seasonal variations occur in this timing. This advance takes place through freezing and, to some extent, through southward advection of existing ice by the north-northeasterly winds which prevail through the winter. Southward advection of Arctic Ocean ice to the Bering Sea is prevented almost completely by Bering Strait, which forms a constriction through which ice cannot move. By about March, the ice margin is at its greatest extent in the Bering Sea. At this time the primary control over ice margin location is an upper ocean layer frontal system, and associated northwest-flowing current, which lies approximately along the 100 m isobath of the Bering Sea shelf (Fig. 7). This frontal system is maintained by input of low-salinity, hence, low density water from ice melting along the ice margin (Muench and Schumacher, 1985). The warmer water south of the front effectively

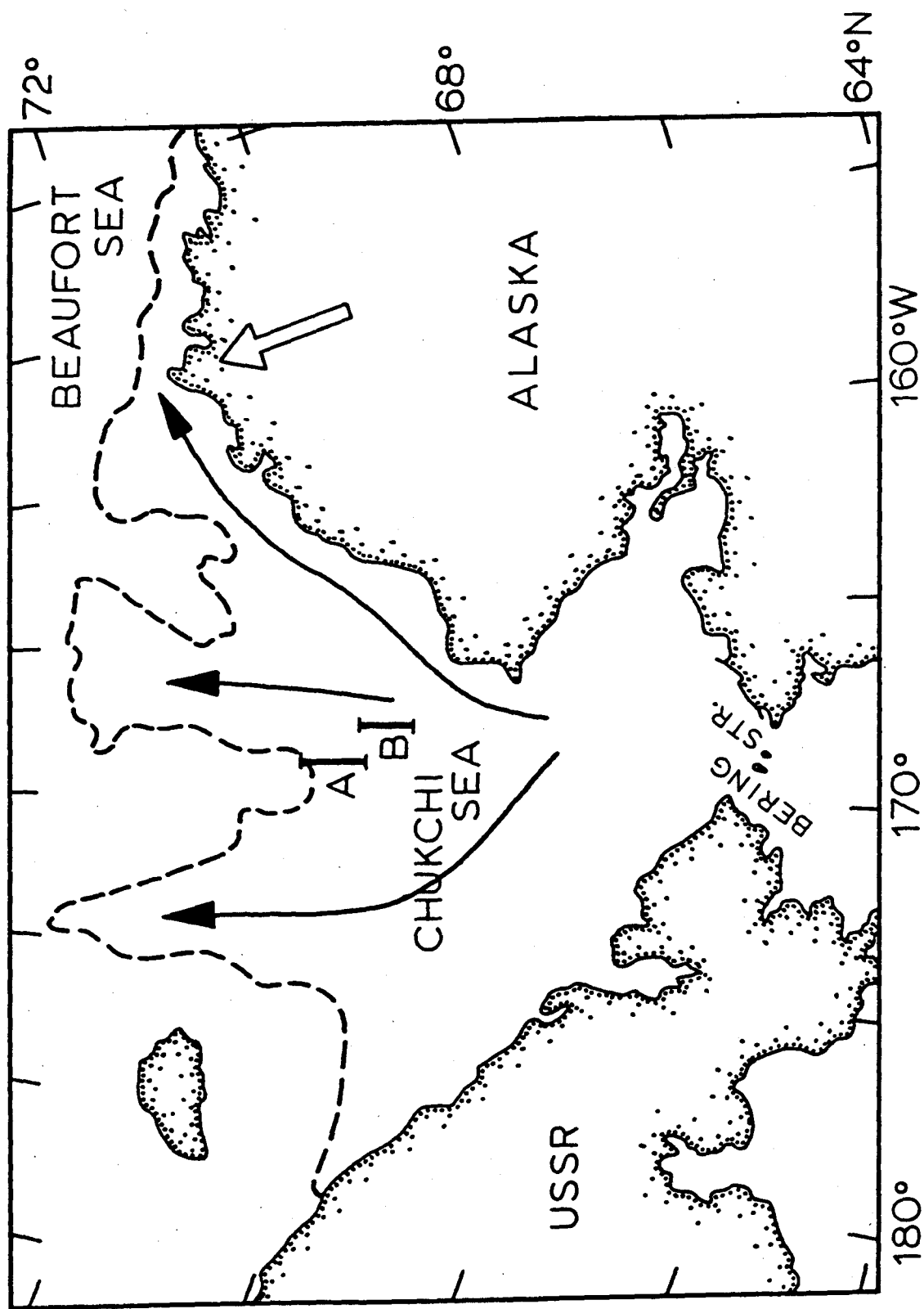

Figure 6. Schematic depiction of the interrelation between northward-flowing warm currents (arrows) and "melback embayments" in the Chukchi Sea ice edge (dashed line) (after Paquette and Bourke, 1981).

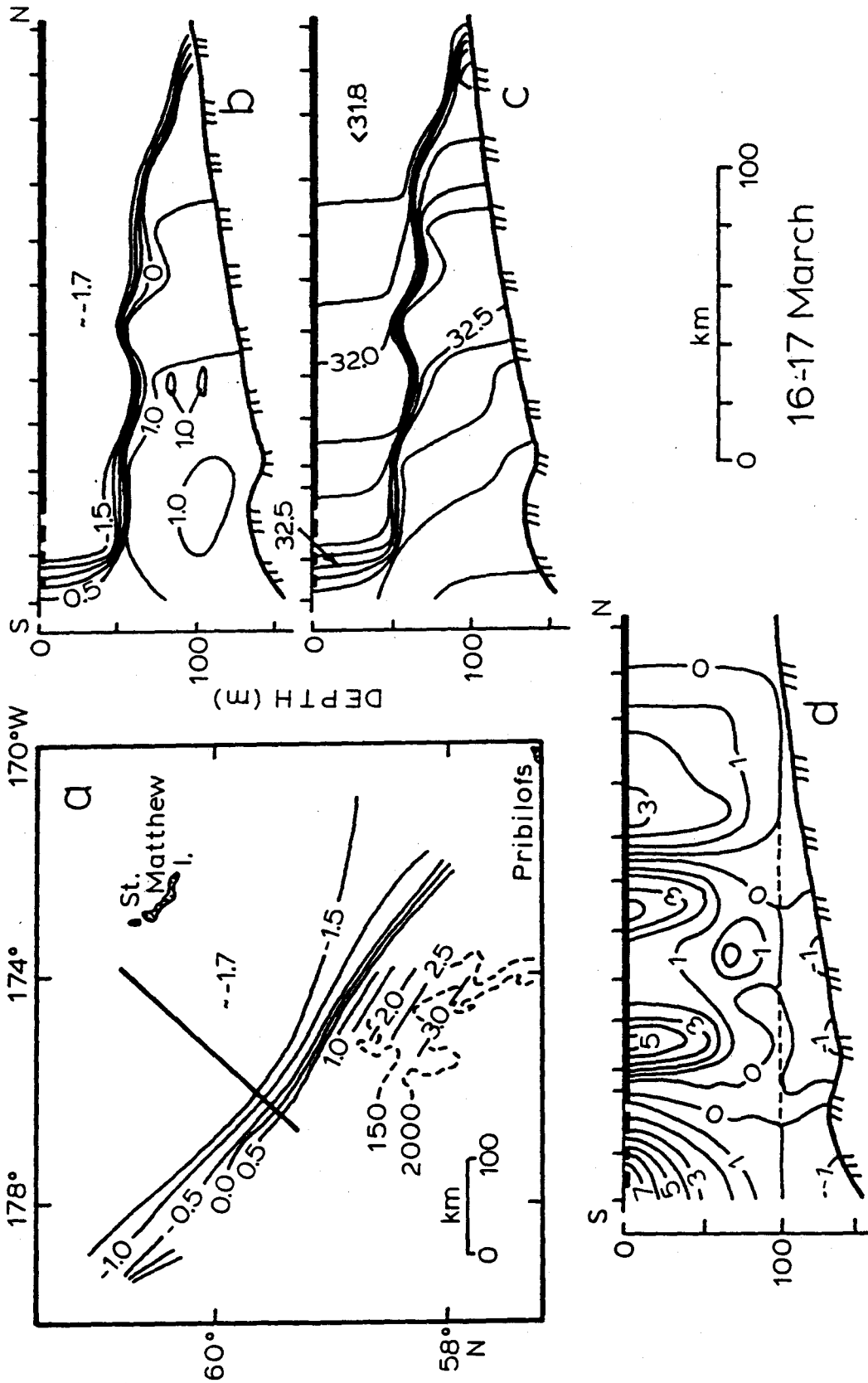

Figure 7. Distribution of surface temperature (a) associated with the winter Bering Sea marginal ice zone front, and vertical distributions of temperature (b), salinity (c) and along-frontal geostrophic current speed positive toward the northwest (d) along a cross-frontal transect whose location is indicated by the heavy line on (a) (after Muench and Schumacher, 1985).

limits the ice to the region north of the front. Any ice blown southward across the front quickly melts in the relatively warm water there, similarly to the situation for the East Greenland Polar Front. The front therefore prevents significant southward migration of the ice edge beyond its approximate mid-winter mean southernmost location.

While controlled primarily by mean oceanic and atmospheric conditions, the instantaneous winter ice margin location in the Bering Sea is heavily influenced by synoptic climatology. The ice margin does not extend as far south during periods of frequent cyclone passage through the region as during periods when the "normal" northeasterly winds prevail (Overland and Pease, 1982) (Fig. 8). The former conditions occur when the Aleutian Low atmospheric pressure system is shifted toward the western Bering Sea, whereas the latter situation reflects a low pressure system farther east, over the western Gulf of Alaska. The cyclones advect relatively warm — frequently above freezing — air from the more southern oceanic areas to the ice-covered regions. In addition, the cyclones have southerly wind components which force the ice margin northward. Finally, the southerly winds generate waves which break up the ice along the margins. The combined warm air temperatures, southerly winds and wave-fractured ice cause a northward retreat of the ice margin. Such a storm event was observed in March 1981 and caused a 100-km retreat of the ice edge to north of its equilibrium location (Muench, 1983). If such

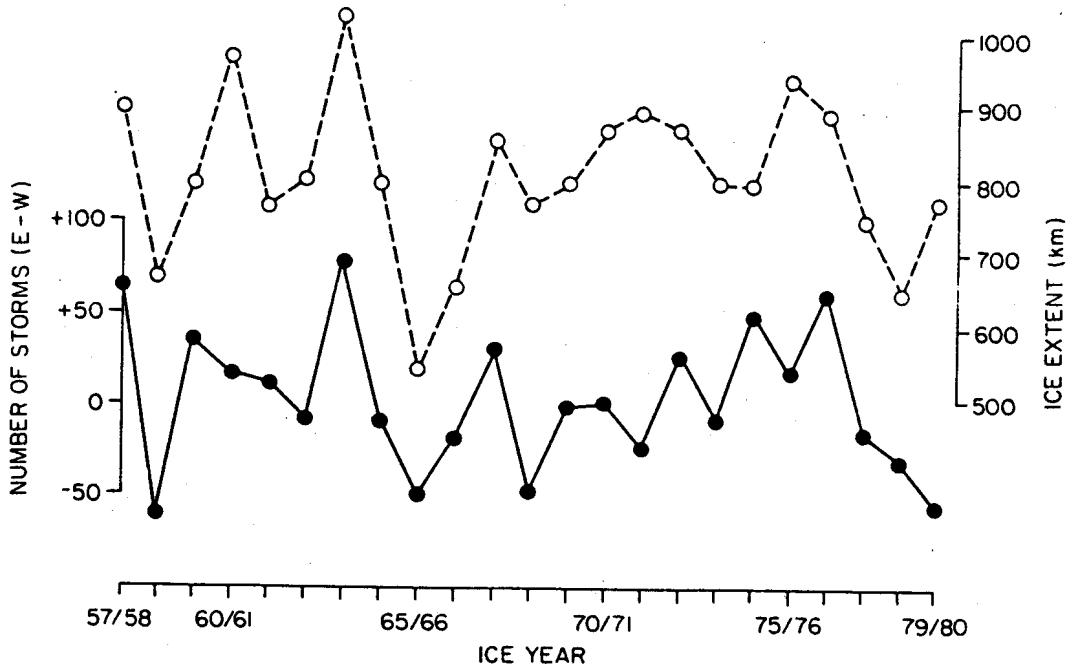

Figure 8. Plot of number of storms in the western Gulf of Alaska minus those in the Bering Sea, and of ice extent, as functions of year (from Overland and Pease, 1982). The correlation between a high level of storm activity in the Bering Sea and light ice years is readily apparent.

conditions prevail in early winter, when onset of the seasonal ice advance normally occurs, the ice advance can be delayed for as long as 2-3 months. Such conditions occurred, for example, during winter 1985 when the Bering Sea ice edge had not advanced southward past about St. Lawrence Island before the end of February, a delay of about 2 months past the "normal" time of ice advance.

The effects of synoptic climatology on instantaneous winter ice edge location in the Bering Sea are mirrored in longer term trends. For example, a warming trend was present in the eastern Bering Sea, from 1977-1979, which was reflected in elevated sea surface temperatures, increased heating in degree days, anomalies in the regional winds and northward displacement of the sea ice margin. This anomaly was found to be correlated with one in the North Pacific (atmospheric) Oscillation far to the south and thence with the northern hemisphere atmospheric circulation (Niebauer, 1983) (Fig. 9). This is consistent with close physical coupling between the ice margins and global scale meteorological processes.

It is important to make note, at this point, of the fact that the ice budgets differ fundamentally between the East Greenland and Bering seas. In the former, the ice is almost entirely passed through the region, being imported as multi-year pack ice from the Arctic Ocean to the north, then being lost from the region either via melting along the ice margin or via export to the south and west. In the Bering Sea, input of Arctic Ocean pack ice to the region is virtually prohibited by the constriction on ice movement presented by Bering Strait. Hence, Bering Sea winter ice is locally formed on the Bering shelf, starting in about November, is advected southward by the northeasterly winter mean winds, and melts at the ice margin. This behavior can be likened to that of a "conveyor belt" whereby ice is formed in the north, advected southward across the shelf by the mean winds, then melted at the ice margin (Muench and Ahlnäs, 1976). Virtually all of the Bering Sea winter ice is therefore first year ice, in contrast to the Greenland Sea where ice is mostly multi-year.

The seasonal ice retreat occurs in the Bering Sea during April-June, when air temperatures rise above freezing and the northeast winds which drive the winter ice "conveyor belt" are replaced by weak and variable winds. The ice cover melts more or less in place as heat is provided by the northward-flowing water from the North Pacific Ocean, from air which is above freezing, and from insolation. The ice retreat is abetted in the northern Bering by the net northward ocean circulation. While weak (1-2 cm/s) over much of the Bering shelf, it strengthens to order 10 cm/s in the channels on the northern shelf which border St. Lawrence Island to the east and west and tends in the absence of northerly winds to advect the decaying ice and meltwater northward into the Chukchi Sea. Similarly, a poorly documented northward flow of water over the westernmost Bering shelf tends to remove the decaying ice more quickly toward the north there than elsewhere on the shelf.

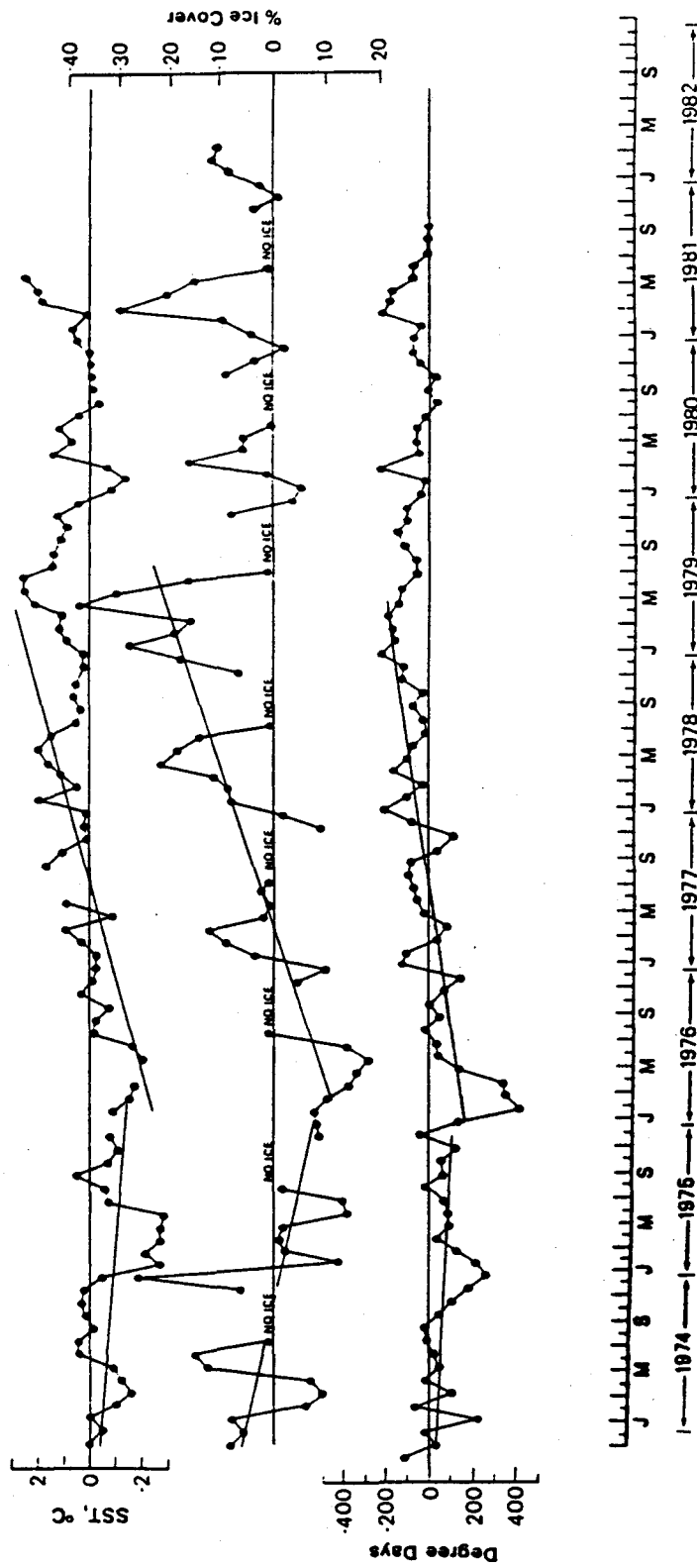

Figure 9. Plot of departures from monthly mean ice cover (as percent), sea surface temperature (SST) and heating degree days for the eastern Bering Sea as functions of year (from Niebauer, 1983). The correlations between these parameters are apparent.

2.3 The Antarctic Sea Ice Margin

The Antarctic ice margin is, during its winter period of greatest ice extent, unbroken by land masses except for the northern tip of the Antarctic Peninsula. This is in sharp contrast to the Arctic situation, where in winter the only continuous ice edges are in the Greenland and Bering seas and, secondarily, in Baffin Bay and the Labrador Sea. The Antarctic has, in addition, a greater seasonal variation in ice edge location than the Arctic (Fig. 3). Only in the Ross and Weddell seas does significant sea ice remain in mid-summer at the time of least ice cover. At other times of year, when the ice cover is more completely developed, the ice margins roughly parallel the general ocean circulation around the Antarctic continent between 60-65°S. The same general balances can be presumed to control the Antarctic sea ice margins as in the Arctic. In other words, the ice margin location reflects a balance between heat available to melt ice along the seaward edge and generation of new ice along, or its advection toward, the edge. The ice budget in the Antarctic Ocean is similar to that in the Bering Sea, i.e., that of a conveyor belt where ice is formed adjacent to the Antarctic continent, is advected seaward and melts at the ice margins. There is no large-scale source of multi-year pack ice, as for the Greenland Sea, which can be advected through the region other than perhaps in some localized areas of the Weddell and Ross seas adjacent to the multi-year pack ice.

The reasons for spring ice breakup and removal from the Ross and Weddell seas are fundamentally different; the former is influenced primarily by local meteorology, and the latter by ocean circulation. In the Ross Sea, as for the rest of the Antarctic, the maximum ice extent occurs in July-October, with the ice edge between about 60° and 65°S. The ice retreat in November-January occurs with formation of a southward embayment along the ice margin in the western Ross Sea. This pattern of retreat is due primarily to advection of ice out of the western Ross Sea under the influence of offshore winds, rather than in situ ice melting (Sturman and Anderson, 1986) (Fig. 10). In the Weddell Sea, primarily in situ meltback occurs due to insolation, increased surface air temperatures and oceanic heat input. Some multi-year ice remains trapped through the summer, however, in the center of the weak, cyclonic Weddell Gyre in the western Weddell Sea. The ocean currents are inadequate to advect the ice from the region and, at the same time, fail to provide sufficient oceanic heat into the region to melt the ice. The effects of this gyral circulation can be seen in an eastward ice promontory which forms in late summer, at the time of least ice extent, as some of the remaining ice is advected eastward by the northern branch of the gyre.

In other Antarctic regions, outside the Ross and Weddell seas, the ice margins range from near coastal or no ice at all in summer to a winter extent resembling a roughly circular edge (when viewed from above the south pole) surrounding the continent at 60-65°S. Undulations or irregularities which occur in the mean ice margin location probably reflect oceanic circulation

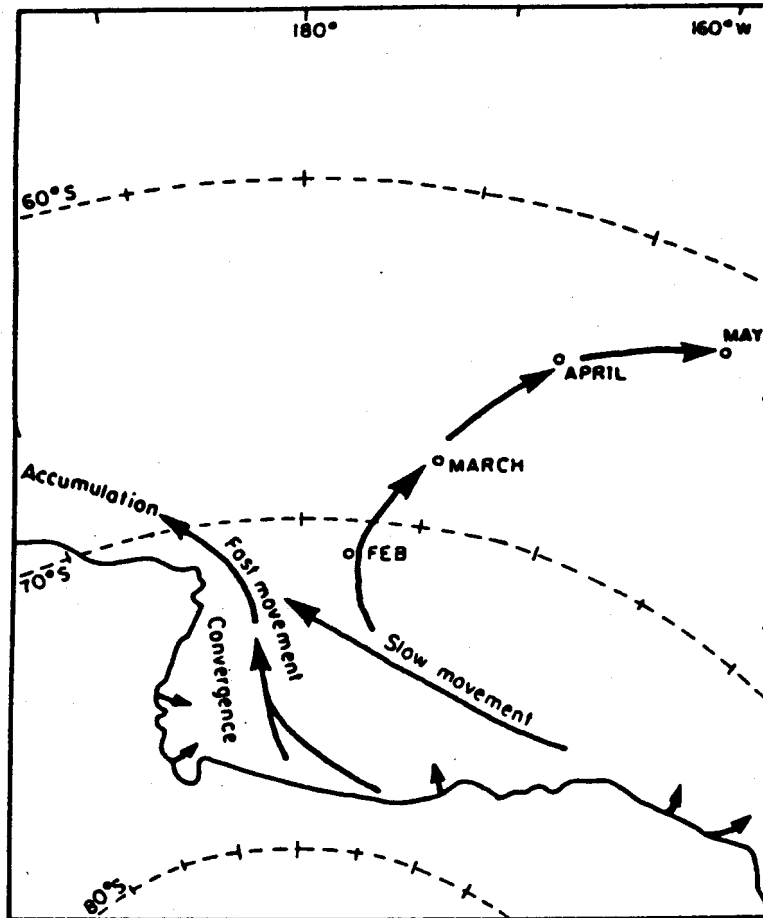

Figure 10. Schematic showing pattern of ice movement in the Ross Sea, where open circles represent the most northerly location along the ice edge for the specified month (from Sturman and Anderson, 1986). Ice retreat occurs when the rate of mechanical removal exceeds the combined rates of input plus freezing.

features. In a general sense, however, we have far less information concerning environmental conditions, such as winds and currents, along the Antarctic sea ice margins than in the Arctic.

2.4 Polynyas

Polynyas are areas of open water which persist, at high latitudes and under freezing conditions, throughout the winter. They are typically surrounded by ice-covered waters. They may, additionally, be somewhat intermittent, i.e., have merely a tendency toward being ice-free rather than actually being open all of the time. They are distributed throughout the Arctic and Antarctic, and are most typically found in constricted channels or adjacent to coastlines. A significant exception was the large winter polynya which was observed in the eastern central Weddell Sea, in deep water and well away from any coastal influence, for several winters in the late 1970's. Polynyas are treated here as part of the sea ice margin because they share the same

general characteristic of very strong horizontal property gradients which typify the open ice margins. They have, in addition, the interesting capability to create localized "micro-climates" both in the ocean and in the local meteorology. The former occurs through ice formation in the polynya and exclusion of brine into the underlying water, while the latter occurs because of the flux of heat and moisture from the open water area of the polynya.

The simplest sorts of polynyas to conceptualize are those which occur regularly along lee coastlines. In these cases, the newly formed ice is simply blown to leeward by offshore winds, while the coastline prevents already existing ice from moving from upwind into the open water area. These polynyas are thus areas of nearly constant new ice formation, but the newly-formed ice never accumulates appreciably. Under extremely cold conditions the ice may actually form so rapidly that the polynya ices over despite an offshore wind. There is, in fact, an optimal set of wind and temperature conditions for formation of this sort of polynya. If there is either too little wind or too low a temperature, the polynya will freeze over. The size of the polynya, in the downwind direction, is controlled by the interrelation between surface air temperature and wind speed (Pease, 1987). Good examples of such polynyas are those which occur along the southern coastline of St. Lawrence Island, Alaska (Fig. 11) (Schumacher *et al.*, 1983) and in Terra Nova Bay, Antarctica (Bromwich and Kurtz, 1984). Others occur throughout the shallow shelf regions which surround the Arctic Ocean, and around the Antarctic continent. The St. Lawrence Island polynya has been shown to have a significant influence, through brine rejection from the newly forming ice, on oceanic salinity and currents in the northern Bering Sea (Schumacher *et al.*, 1983). Periods when rapid freezing, hence also brine rejection, occurred coincided with westward current events which are presumed to have resulted from the density increase of the brine-enriched water. Since this polynya was a typical lee coastline polynya, it can be supposed that other such polynyas have similar effects on their surroundings.

A second sort of polynya occurs when winds, currents or a combination of these act through a channel constriction in such a way that ice is physically removed from the restricted area while existing ice is prevented from entering by a "structural arch" which forms at the upstream/upwind end of the constriction. A good example of such a polynya is the North Water area, where southward currents and northerly winds remove newly formed ice from the narrow constriction at Smith Sound in northern Baffin Bay, the constriction preventing southward movement of existing ice into the region (Muench and Sadler, 1973). Wind-driven upwelling along the northeastern Greenland coastline may also contribute deep, warm oceanic water to the upper layers, and this heat input helps to prevent ice formation. A second example is the tendency toward open water which occurs in the Bering Strait when north-northeast winds blow ice southward away from the Strait and Arctic Ocean pack ice is prevented from entering by the narrow constriction presented by the Strait. Smaller such features also occur throughout the Canadian Arctic Archipelago (Topham *et al.*, 1983). In many of these cases, vertical mixing of

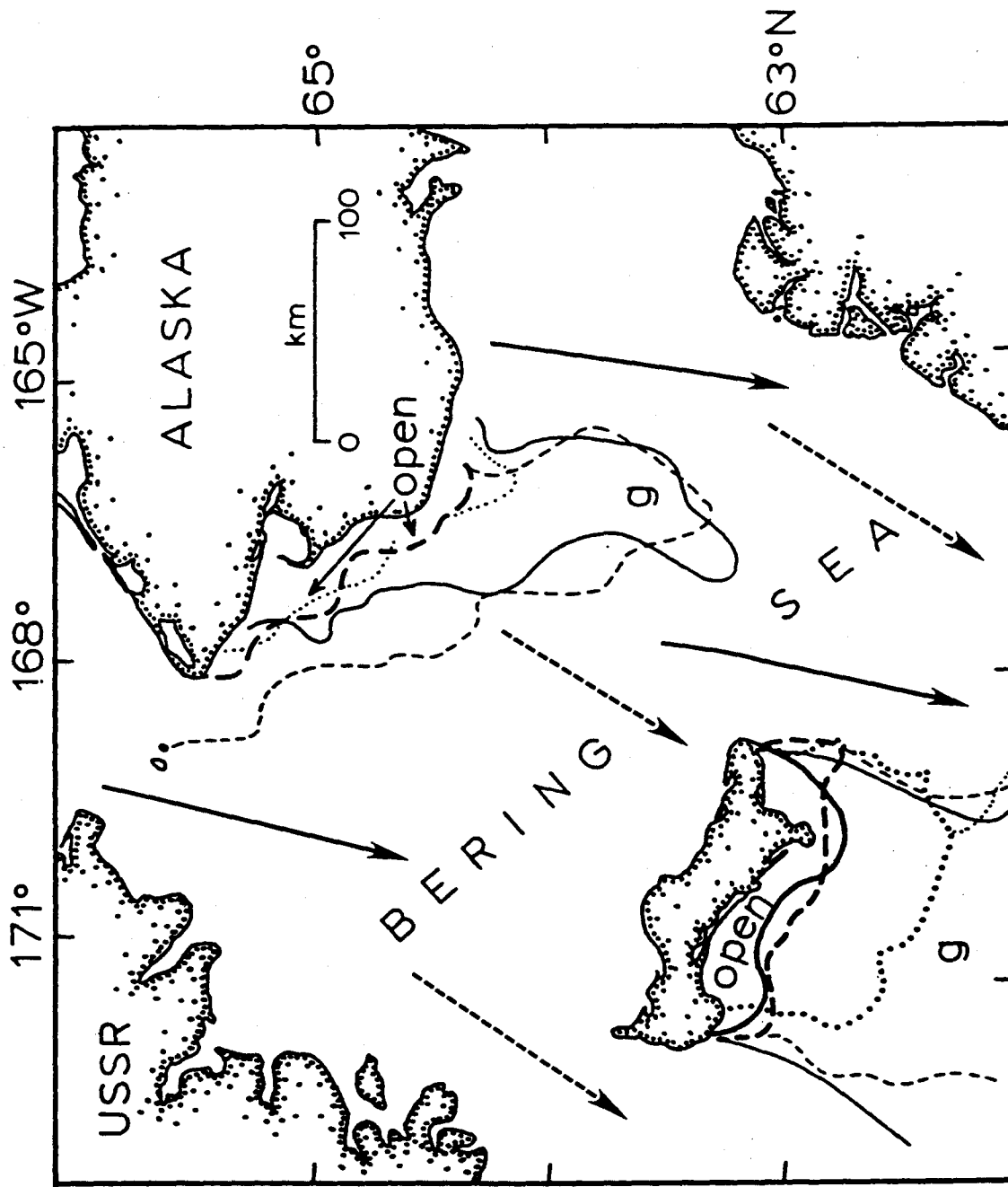

Figure 11. Schematic showing the configurations of two polynya areas in the northern Bering Sea (from McNutt, 1981). Solid arrows indicate wind direction, and dashed arrows ice motion, when the polynyas are present.

the seawater due to the channel constriction acts to provide some oceanic heat to the surface, which further contributes to prevention of ice formation. The same vertical mixing may also distribute frazil ice through the water column before it has a chance to congeal at the surface, with the currents through the passage then sweeping it downstream, away from the open water area.

A large polynya which was observed in the central eastern Weddell Sea during several winters in the late 1970's was not due to any of the above processes and was, in fact, of uncertain origin. There was no nearby lateral boundary, such as a coastline, to restrict ice from entering the region. The most likely explanation of its origin now appears to be deep ocean convection which provided sufficient oceanic heat to the surface to prevent ice formation (see for example Parkinson, 1983). Since oceanographic observations were not obtained from the region during the period when the polynya was observed, there is no information available concerning the associated oceanic conditions. Much of the insight regarding its formation has been obtained through construction of numerical models.

3. SMALL SCALE FEATURES AND PROCESSES AT THE ICE MARGINS

This section describes those physical features which are common to the sea ice margins, irrespective of geographical location, and describes and discusses the mechanisms which lead to formation of these features.

3.1 Physical Description of Small Scale Features

A sea ice margin typically has a continuous gradation in physical ice configuration between open water and the solid pack ice (Fig. 12). The primary gradation is in terms of size, with smaller pieces of ice nearer to the open water and sizes increasing as the interior pack is approached. Secondly, the ice tends to be more rounded near the open water edge and more angular farther in toward the solid pack. There are exceptions to this general description, and these will be noted below.

First, bordering the open water, we typically find a region of small (from a few cm to several tens of cm, but generally less than 1 m), irregularly shaped and usually rounded bits of brash ice. If the water temperature is above freezing, this brash will consist of broken bits of floes, which are actively melting, separated by open water. If, on the other hand, the air temperature is below freezing and the water has been cooled sufficiently for freezing to commence, this brash may be incorporated into a matrix of grease and pancake ice, eventually to become part of the newly forming ice cover. If temperatures are low enough and persist for long enough, a very extensive region of grease and then pancake ice may develop seaward of the region of brash ice. In the northwestern Weddell Sea, where the ocean circulation is very weak and the ice motion is dominated by wind forcing, the autumn ice advance can occur very rapidly in the presence of low

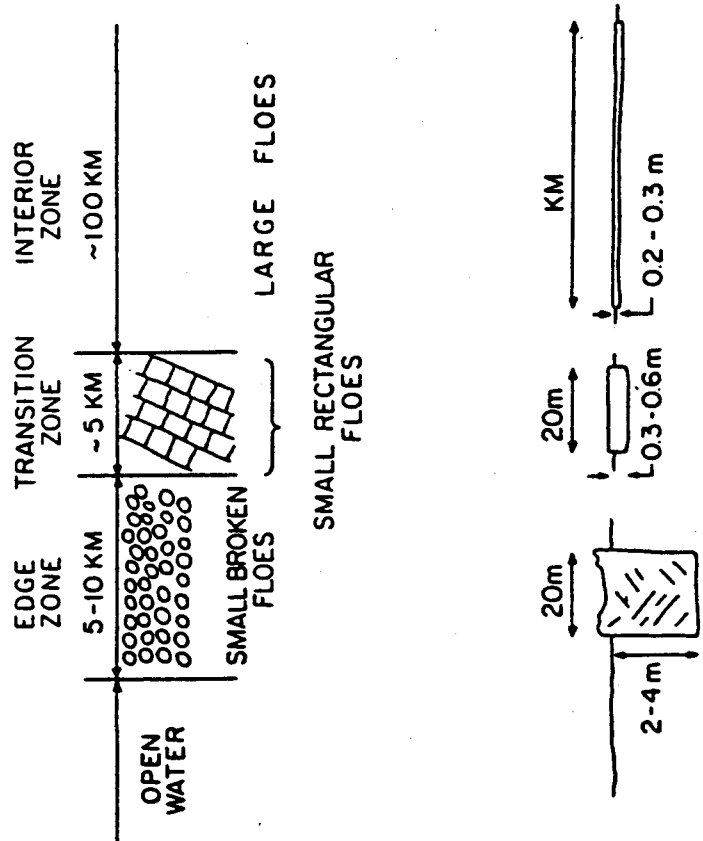
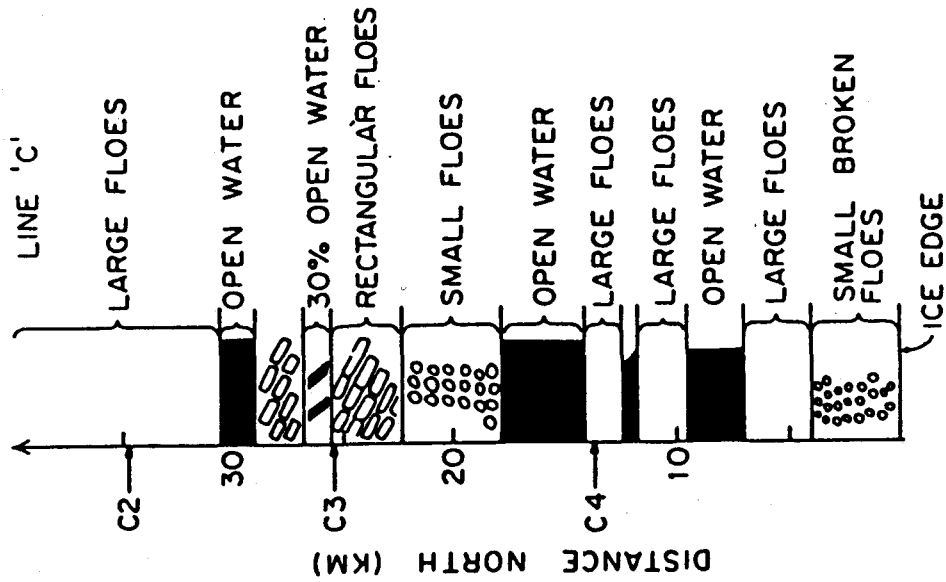

Figure 12. Two different depictions showing transitions in sea ice configuration across the marginal ice zone. The left-hand frame is a conceptualization (Bauer and Martin, 1980), while the right-hand frame depicts actual conditions (Cavalieri, 1983).

air temperatures and off-ice winds once the surface waters have been cooled to near freezing. Under these conditions, the fields of pancake ice which are the initial stages of a developing winter ice cover can extend for several tens, possibly hundreds, of kilometers seaward from the existing ice. In the East Greenland Sea, in contrast, the ice is bordered closely in winter by an oceanic frontal system so that warm water lies seaward of the ice edge; the region of newly formed grease and pancake ice can only extend seaward as far as the warmer water, beyond which point oceanic heat inhibits ice formation. The far more rapid advance of ice in the Weddell than in the Greenland Sea is commensurate with the greater seasonal variability in the Weddell Sea. The early winter ice advance in the Bering Sea can occur very rapidly, similarly to the Weddell Sea, up to the point where the ice margin approaches the shelf break and elevated water temperatures seaward of the frontal system inhibit new ice formation.

If the ice edge has recently been subjected to on-ice winds and concurrent wind wave activity, there is typically a region in the outer ice margin where floes have been rafted atop one another, and fractured, by the combined wind and wave action. Here, the effective ice thickness may be 2-3 times greater than that of the original, individual floes. In the Bering Sea, this zone has been observed to be 5-10 km wide. The line of transition between the outer zone of brash ice and this region is often exceedingly sharp. The pieces of sea ice in this region may resemble bits of multi-year pack ice, 2-4 m thick and 20 m or so in diameter. These may or may not have actually frozen together into coherent structures, depending upon air and water temperatures subsequent to the rafting event which formed them. These rafted floes are particularly common along the Bering Sea winter ice margin, presumably because Bering Sea ice is first-year ice which is relatively easily rafted by forces near the ice edge. They are, moreover, quite obvious when they are present in this location, because multi-year pack ice is not found along the Bering Sea ice margin. A step-wise advance of the ice edge, with off-ice winds, freezing and advance episodes interspersed with on-ice winds, rafting and possibly temporary ice retreat, would result in distribution of these rafted floes throughout an ice field as they were left behind the advancing ice edge. Such a stepwise advance is typical for the Bering Sea during the seasonal ice advance. If advance of the edge were due primarily to actual seaward advection of existing ice, rafted floes would move with the edge and would not be expected to occur in the interior. Rafted floes generated by this mechanism would be expected to be quite common in the Weddell Sea, also.

If conditions near the edge are conducive to freezing, the ice cover increases through congelation of individual smaller pancakes into pans which then coalesce into floes. Along a retreating or stationary margin, floes are smaller near the edge because of the mechanisms, discussed below, which tend to fracture them near the edge. It is possible, and not infrequent, for freezing and fracturing to occur simultaneously along an ice margin, in which case the relative importance of the two opposed processes will determine the ice configuration. This would occur, for example, in the case of off-ice winds, low surface air temperatures and an on-ice ocean wave

field. Farther into the ice the floe sizes become larger, until they have reached an equilibrium size which reflects a balance between mechanisms which tend to maintain their structure (internal strength and freezing) and those which tend to break them apart (internal ice stresses and ocean wave action). This "equilibrium" floe size varies both with season and with geographical location. For example, very large floes — as large as 20-30 km in diameter — have been observed within a few km inside the northwestern Weddell Sea ice edge, where weak currents and surface winds contribute to an environment where large floes can persist unbroken (unreported data from March 1986 AMERIEZ cruise). On the other hand, floes tend to be much smaller — often less than a kilometer in diameter — inside the East Greenland Sea marginal ice zone. Several factors contribute to the smaller floe sizes here. The shears associated with the East Greenland Current create internal ice stresses sufficient to fracture larger floes. There frequently is considerable ocean surface wave activity in the region, which fractures large floes for a great distance into the ice.

Ocean surface waves, generated seaward of the ice edge and propagating beneath the ice cover, lead to a decrease in floe sizes as one progresses seaward in the ice margins. Such waves are damped out by the ice, the rate of damping being dependent upon the interrelations between wavelength and floe dimensions. At the actual ice edge, the undamped waves break the floes up into the observed small pieces of brash ice. As the waves propagate beneath the ice, their amplitudes decrease and so does their ability to fracture the ice. The higher frequency, shorter wavelength waves are selectively damped out first and nearest the edge, whereas the longer waves propagate farther beneath the ice. These longer waves can be quite effective at fracturing the larger floes, and wave-induced fracturing occurs for distances exceeding 50 km into the ice.

During periods when winds are directed in an off-ice sense, the pack becomes divergent, with the ice edge moving to seaward and leads opening within the pack to satisfy continuity. There are a number of possible reasons for this divergent behavior. A primary reason appears to be that the ice is aerodynamically and hydrodynamically rougher at the ice margins than in the interior, as a consequence of being broken and rafted by the severe wave and wind conditions along the margins. Consequently, ice at the margins responds more strongly to a given wind field than ice in the interior and, in the presence of an off-ice wind, will diverge. A second reason is that the ice along the margins is not subject to appreciable internal ice stresses and so may respond quite rapidly to an applied wind stress in something approaching a "free drift" mode wherein only wind and water drag stresses are significant to the overall force balance acting on the ice. A third mechanism operates whenever conditions are such that ice is melting along the edge, so that a layer of low salinity water is present underlying the ice. In this instance, the density interface between this low salinity layer and the underlying, more saline and denser water acts as a "zone of slippage". The interface prevents momentum transfer from the upper to the deeper layers, allowing the upper layer, along with the ice, to effectively "slide over" the lower

layers so that divergence can occur much more quickly than in the absence of the meltwater. This mechanism has been successfully demonstrated theoretically (McPhee, 1983), but its demonstration in the field has proved difficult because it has not been possible to separate it from the other processes leading to divergence.

The initial divergence of ice which results in opening of leads at the inner ice margin, sometimes more than 100 km inward from the ice edge, is of uncertain origin. In the Bering Sea, this may result in part from alternate compression and dilatation of the sea ice margin region by inertial currents which occur in association with the frontal structure underlying the ice margin there. As much as a 3-4% compression/dilatation may result from these motions, which have about a 13-hour period (the local inertial period) and were observed in current records to be particularly energetic in mid to late winter (Lagerloef and Muench, 1987). Similar inertial fluctuations were also observed, using current meters, in the East Greenland Current (Muench *et al.*, 1986). These fluctuations, coupled with the mean current shear resulting from the East Greenland Current, may contribute to initial divergence of the ice cover there. The patterns of initial ice divergence and ice margin circulation are not well known in the Antarctic. However, one would expect the same generalized processes to apply there as in the Arctic regions.

Divergence of ice along the margins is, finally, abetted by the local wind field. The roughness of ice along the outer margin leads to a localized region of wind deceleration and acceleration which can contribute to acceleration of the loose, drifting ice to seaward. This topic is discussed further in Section 6.

Ice in a divergent, free-drifting mode can serve as an effective "tracer" for motions. One such instance was observed in the Bering Sea, where long bands of ice aligned themselves in approximately the along-wind direction in response to the lines of convergence underlying atmospheric roll vortices (Muench and Charnell, 1977). These bands were tens of kilometers in length and spaced 5-10 km apart. On a much smaller scale — of order hundreds of meters — freely drifting ice is aligned into wind rows overlying the lines of convergence associated with Langmuir convection cells.

A very commonly encountered situation is one where the ice being blown to seaward forms into ice bands or streamers which are roughly normal to the wind direction. These bands are of order 1-10 km long, and 100 m to 1 km in width (in the downwind direction). They advance to seaward rapidly, as free drifting ice no longer subject to internal ice stresses, and constitute a mechanism for rapid advance of ice into the open water. If the ice edge is at its equilibrium location, then these bands drift into water which is above the freezing point and melt rapidly. In this case, the formation and movement of these bands can significantly enhance the melting of ice along the edge. Some possible mechanisms for their formation are discussed below.

3.2 Stresses at The Ice Margins

Given the existence of the mobile, fractured ice cover which typifies the sea ice margins, a number of stresses can be identified which act on the ice and so influence both its movement and distribution. Here, it will be helpful to differentiate between convergent and divergent ice margins. Though many physical properties are common to both, there are sufficient physical and process differences that their separation is convenient for discussion purposes. A convergent margin is one where the ice has been compressed, usually by on-ice winds and waves, occasionally by ocean currents, so that there is no open water near the actual ice edge. It is perhaps easiest to visualize a convergent ice margin through comparison with the opposite case of divergence, where ice has been scattered to seaward by winds or currents so that there is considerable open water inside the ice edge. In such a case, bands and streamers of ice are advected well out into the open ocean seaward of the ice. In extreme cases the seaward extent of the ice cover becomes a diffuse region of gradation between solid pack and open water, and it is impossible to define an ice "edge". Typically, an ice margin will undergo alternating episodes, under the influence of local winds, of convergence and divergence. One such series of episodes has been particularly well-documented along the Greenland Sea summer ice margin (Johannessen *et al.*, 1983). The results of these observations are shown in Fig. 13.

The forces which act on ice at the sea ice margins arise from the same sources as those which act on ice in the interior pack; however, the balances between these forces may vary considerably from the ice margins to the interior. The dominant forces acting on floating ice are wind stress, water drag, internal stress within the ice, stress exerted as a consequence of both surface and internal wave activity beneath the ice, and stress due to any sea surface slope which may be present as a result of ocean currents. Of these, the internal ice stress is typically less important at the ice margins than in the interior, whereas the wave-induced stresses are likely to be more important. Wind and water stress are likely to be larger at the margins than in the interior, because the margins are often the sites of more energetic winds and currents. These are each treated in greater detail below.

I shall first discuss the internal ice stresses, compression and shear, within the context of the sea ice margins. Inclusion of these stresses is essential when describing the behavior of ice in the interior pack, where the ice is either a continuous sheet or, at the very least, made up of separate large pieces in very close physical contact. Because of this continuity, compressive and shear forces can be transmitted through the ice cover. By definition the sea ice margins are, however, regions of transition between the solid, interior pack ice and the open water. These regions are made up of ice which is highly fractured and interspersed with open water areas, particularly nearer the open water. The individual floes are smaller than those found in the interior, and the spaces between are often filled with smaller, broken ice or slush which can act as a "lubricant" to inhibit transfer of shearing stresses. Finally, the ice margin, bounded to seaward

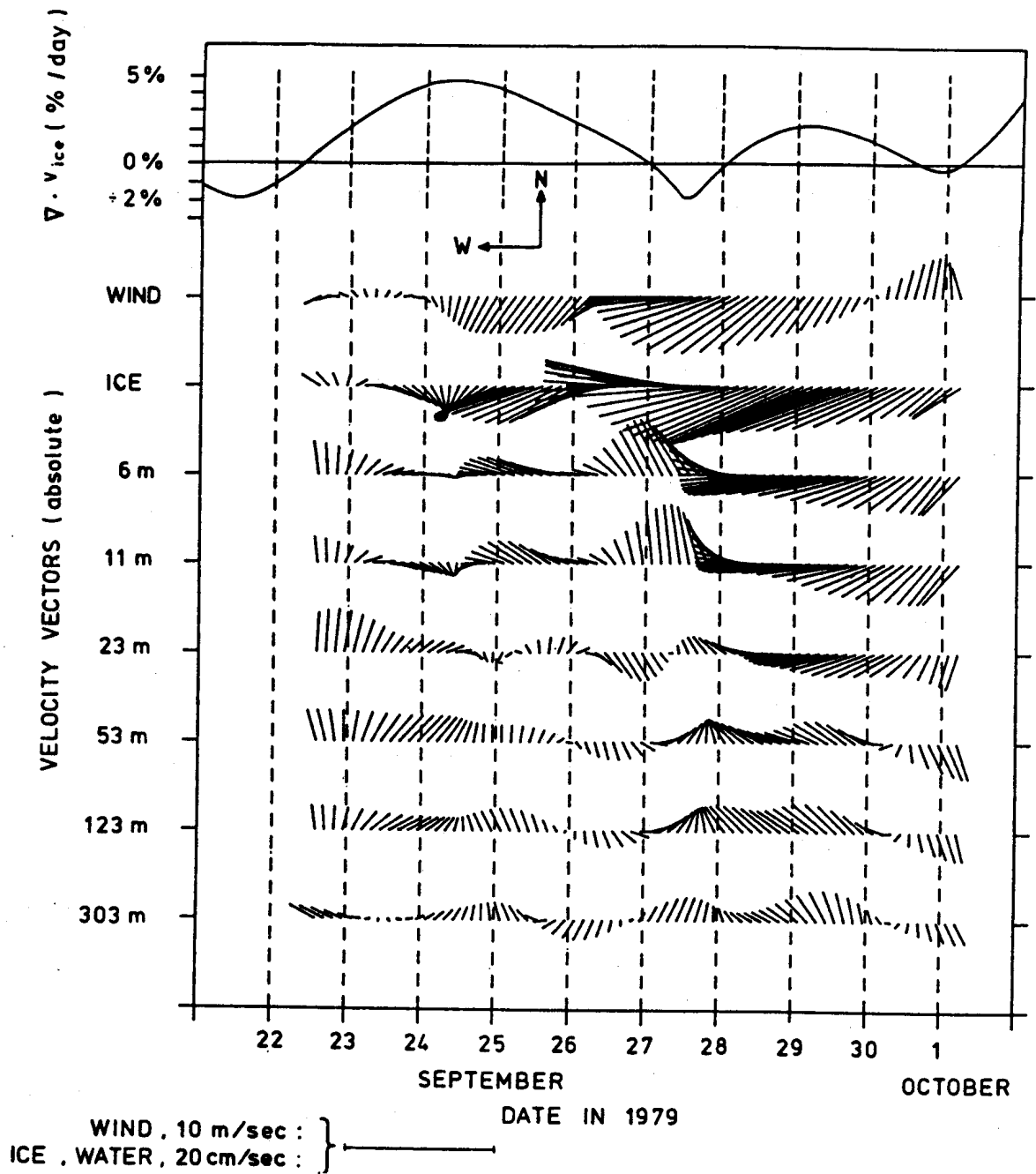

Figure 13. Wind-driven ice divergence as computed from the tracks of ice drift buoys in the Greenland Sea marginal ice zone (from Johannessen *et al.*, 1983). The topmost plot shows ice divergence. Below this are the wind velocity as measured from a buoy, ice velocity, and currents at six depths beneath the buoy. The correlations among ice divergence, wind and ice movement are apparent.

by open water, is free to accelerate in response to applied stresses, and is therefore a zone in which internal stresses cannot accumulate to any significant extent.

Compressive forces are not significant, relative to other forces, at the sea ice margins unless the margins are in a convergent mode. These forces are generated primarily through wind and water stresses acting over large expanses of pack ice, with one or more boundaries of the pack being constrained so that the ice cannot accelerate in response to the applied stress. At the ice margins, unlike the interior, there is an open seaward boundary. In the event that the result of the wind and current stresses is directed parallel to the ice edge, the ice simply accelerates parallel to the edge, in response to the stress, and compressive forces are not built up. A second situation occurs when wind and current force is exerted in the on-ice direction. In this instance the ice is initially convergent as the open water areas in the pack adjacent to the edge close. There is, however, no large area of pack ice to seaward over which wind or current stress can be accumulated. Therefore in this case we can speak of a compressive, or compact, ice edge, but the actual compressive forces developed will be small when compared with those generated in an internal pack ice field. In fact, the major on-ice stresses in such a case may result from radiation stress exerted by an on-ice wind-driven surface wave field impacting on the ice edge. Observations in the East Greenland Sea have suggested that ice under these conditions retains some of the plastic behavior characteristic of interior pack ice so that some compression and shear is transmitted (Lepparanta *et al.*, 1986). Finally, the drag forces may be directed in an off-ice sense, toward the open water. In this case, the individual floes are simply blown out over the open water, the pack at the ice margin becomes divergent, with large areas of open water interspersed with bands and streamers such as those described above, and no compressive stress is generated or transmitted.

Shearing motion between individual ice floes is common along the ice margins. This may reflect the influence, through water drag, of shear in the underlying ocean currents which are often quite strong there. Additional shear may be introduced by winds directed along the ice edge, then intensified at the margin due to boundary layer differences between the ice and open water. This shear is not, strictly speaking, transmitted through the ice but is rather a reflection of what is going on in the ocean and atmosphere at the ice margin. This shearing motion can be observed in the rotation of ice floes at the margins and, if strong enough, contributes to mechanical destruction of the ice by physically eroding the edges of floes. Because ice at the margins is typically broken and rounded, especially near the edge, it is uncertain how effectively shear can be transmitted through the ice cover. An example of this sort of shear, at the ice margin, is shown in Fig. 14, where ice floes are seen to rotate in response to the shear associated with the East Greenland Current. Shearing motions have also been observed along the Bering Sea midwinter ice edge as a result of the frontal current which underlies the edge. Both the Greenland and Bering Sea ice edge currents are discussed in more detail below.

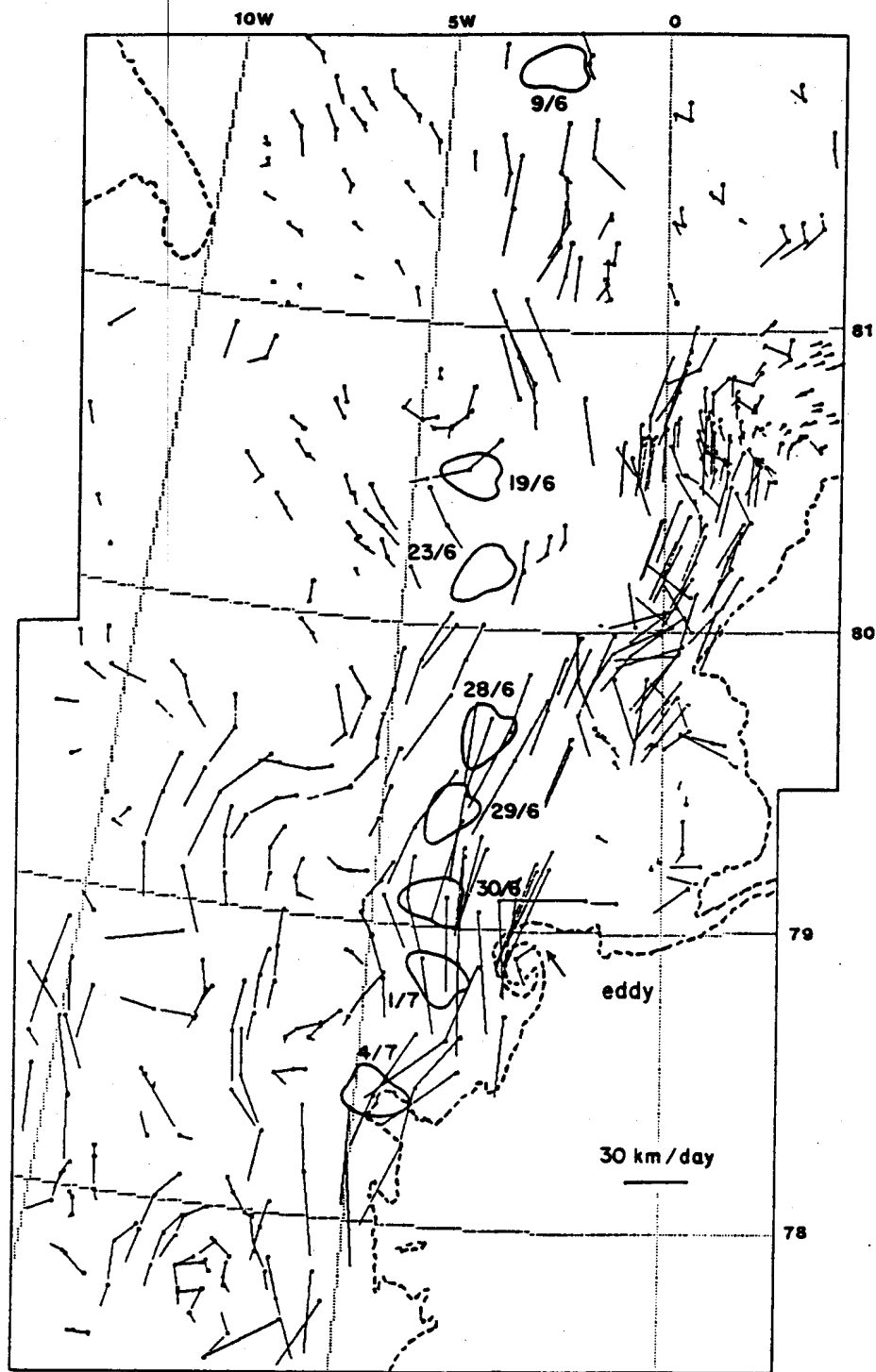

Figure 14. Schematic showing rotation over time of a large ice floe in response to current shear in the Greenland Sea marginal ice zone (from Gascard *et al.*, 1988). Numbers indicate day/month. Vectors indicate velocities of smaller ice floes. Dashed line indicates ice edge location, showing a cyclonic eddy which has entrained ice along the edge.

Determination of the nature of compressive and shear stresses at the sea ice margins has been a primary goal of much of the research carried out there. Knowledge of the physics controlling such stresses is needed in order to provide realistic parameters for predictive modeling of ice margin processes. This knowledge has been elusive, due primarily to the rapidly varying and spatially complex nature of the ice margins. The ice cannot be assumed to act as a cohesive sheet in the same fashion as solid pack ice. Nonetheless, under certain conditions considerable compression and stress can be transmitted through ice at the margins (Lepparanta *et al.*, 1986). Under other conditions, the flow of ice at the margins can be conceptually viewed as that of a layer of ball bearings on a flat surface, capable of flowing around an obstacle without exerting a stress. This conceptualization is particularly apt for the Bering Sea ice margin, where just this sort of ice behavior occurs as the ice flows around islands on the shelf (C.H. Pease, PMEL/NOAA, personal communication).

While internal ice stresses play an uncertain and highly variable role at the ice margins, those stresses resulting from wind and current drag are consistently of greater importance. The basic physical principles behind these driving forces are found in boundary layer theory. For our purposes here, it is sufficient to note that ice at the margins is aerodynamically and hydrodynamically rougher than in the interior pack ice zone. Ice at the margins also presents a considerably rougher surface than the open water to seaward. Hence both wind and ocean current stress, which are linear functions of the roughness (expressed as a drag coefficient), are particularly important at the margins relative to other forces.

One of the commonly observed conditions at a sea ice margin is that of a divergent ice edge driven by off-ice winds. This is the usual situation during the period of seasonal ice advance and growth, and typifies the Bering Sea throughout the winter. In this case, the ice movement is controlled primarily by wind stress, water drag and the influence of the earth's rotation upon the ensuing drift. Under these forces, the ice separates from the pack and drifts rapidly into open water as bands and streamers. Seaward drift speeds of more than 50 cm/s (about 1 knot) were observed along the Bering Sea ice edge during March 1983 [unpublished data]. The scalar balance of forces for such a free drift case can be approximated as

$$T(w) + T(a) - mfU + T(b) = 0 \text{ (from Martin } et al., 1983)$$

where $T(w)$ and $T(a)$ are the water and air stresses, U is the ice velocity, m is the ice mass per unit area, f is the Coriolis parameter and $T(b)$ is a residual stress needed to balance the equation. Values for the water and air stress terms are dependent upon both the drag parameters chosen, which depend in turn upon the local sea ice roughness, and the observational accuracy of the wind and relative ice-water motions. Observations taken for free drifting ice in the Bering Sea marginal ice zone have been used, in conjunction with the above equation, to compute a stress

balance for the free drifting ice (Martin *et al.*, 1983). The results of these computations showed that about 66% of the stress balance was accounted for by the wind and water stress terms (Table 1). The remaining forces were accounted for in terms of radiation stress exerted on the drifting ice by locally wind-generated ocean surface waves. In cases where there is an appreciable ocean current underlying the ice, there may be a significant current-generated water stress and, additionally, there may be a stress term – not included in the above equation – which is due to gravitational acceleration down the sea surface slope associated with the current. The equation presented above was first used within the context of ice edge band motions, which are generally of a scale small relative to that of ocean currents.

Locally wind-generated ocean surface waves are believed to be important in the formation of those ice margin bands which are oriented approximately normal to the off-ice wind direction (Wadhams, 1983), and this provides an interesting and quite widespread special case of an ice margin force balance. Once divergence of the pack at the margin has been initiated, leads open inside the pack within which steep, short-period wind waves are generated in response to the

TABLE 1. Upper table shows the relative balance between stresses acting on sea ice in bands in the marginal ice zones, while lower table shows the balance for ice in the pack interior (from Martin *et al.*, 1983). Terms in the tables are identified beneath. The large stress unbalance in the ice band case is believed to be due to radiation stress from surface waves.

Stress	\hat{x}	\hat{y}	Magnitude	θ
τ_W	0.93	0.96	1.34	44°
τ_a	-0.39	-0.53	0.66	216°
τ_c	-0.06	+0.13	0.14	333°
τ_B	-0.48	-0.56	0.74	221°

Stress	\hat{x}	\hat{y}	Magnitude	θ
τ_W	0.42	0.48	0.64	41°
τ_a	-0.45	-0.54	0.70	220°
τ_c	-0.02	+0.05	0.05	336°
τ_B	0.05	+0.01	0.05	79°

τ_W , water stress; τ_a , air stress; τ_c , Coriolis stress; τ_B , additional stress required for balance; all in N m^{-2} . Also, \hat{x} , east component; \hat{y} , north component; θ , direction.

off-ice winds. These wind waves exert a radiation stress on the downwind ice (i.e., that to seaward), and contribute to the seaward acceleration of this ice and to the overall divergence along the margin. This radiation stress is significant because the waves are almost completely reflected from the floes. Once the floes have separated from the main portion of the pack to become identifiable bands, they tend to accumulate into a smaller number of larger, more substantial bands. The integrity of these bands is maintained by the wave radiation stress acting on its upwind side. In the above equation, $T(b)$ represents the wave radiation stress which is, for the case of total reflection postulated here, given by

$$T(b) = F(r) = 0.5 \rho g a^2 R^2$$

where R is the amplitude reflection coefficient, a is the amplitude of the incident waves, ρ is the water density and g is the acceleration of gravity. The force on a given floe is Fd where d is the floe diameter. For a 20 m diameter floe, with $R = 1$ and $a = 0.1$ m, then the radiation stress induced force on the floe is about six times greater than the wind stress for a 10 m/s wind and clearly dominates the force balance acting on the floe.

The regular spacing typically observed between ice bands may reflect the presence of internal waves in the underlying water (Muench *et al.*, 1983). The water column at the ice margins typically has a layered structure with an upper mixed layer overlying a deeper layer which can be either stratified or well-mixed. These layers are often, especially during summer, separated by a region of strong vertical density gradient which can support the generation and propagation of internal waves. Such waves might be generated, for instance, by moving ice keels in the same fashion as the Nansen "dead water" effect wherein propeller-driven vessels can expend large amounts of power simply generating internal waves along a shallow density gradient zone rather than in forward motion. Winds blowing in an off-ice sense over a moving ice edge might also generate such internal waves (Muench *et al.*, 1983). Both ice edge advance rates and typical ice floe drift velocities are compatible with internal wave speeds computed for the ice margins (Table 2). The alternating surface bands of convergent and divergent currents associated with the internal waves would serve to modulate the already moving ice into bands, and provide a possible explanation for the regular spacing of these bands.

A numerical model has been developed which explains ice banding along a divergent margin in terms of the dynamic interactions between the ice, the ocean and a temporally varying wind field (Häkkinen, 1986a). Field data have in general been inadequate to rigorously test the various theories for band formation. Given the wide variety of conditions under which such bands have been observed, however, it is likely that all of the theories will have some validity under certain conditions. The considerable interest in band formation, resulting in the variety of

TABLE 2. Computed first-mode internal wave speed c in cm/s for the Bering Sea and Greenland Sea marginal ice zones (from Muench *et al.*, 1983). These speeds were computed for regions two-layered in density, and the terms are defined beneath the table. The computed speeds c are similar to, and frequently the same as, ice drift speeds in the marginal ice zones.

Case	h	c (cm/s)				
		$\Delta\rho = 0.00010$	$\Delta\rho = 0.00025$	$\Delta\rho = 0.00050$	$\Delta\rho = 0.00100$	$\Delta\rho = 0.00500$
Bering Sea: bottom depth ~100 m	25	14	22	30	42	96
	50	16	26	36	51	114
	75	15	24	34	48	107
E. Greenland Sea: bottom depth >1000 m	25	15	24	35	49	109
	50	22	35	49	69	155
	75	27	42	60	85	189

$\Delta\rho$ is the density difference in g/cm^3 across the interface between the upper and lower layers; h is the depth of the interface in meters.

theories which have been put forth for their origin, reflects their widespread occurrence and the belief that they have a significant influence on the rate at which ice melts along a margin.

A tremendous variety of possible force balances is possible at the ice margins. Controlling factors include the wind speed and direction, underlying current fields, incident ocean surface and internal wave fields and the character of the ice both in terms of roughness and internal strength. It is clearly impossible to include discussions of all these possibilities. The above is intended to provide illustrative examples rather than any attempt at an exhaustive listing.

4. MESOSCALE OCEANIC FEATURES AT THE ICE MARGINS

The expression "mesoscale" refers to features which have size scales greater than about 10 km but less than the several hundred kilometer scales which characterize ocean basins. Mesoscale processes in the ocean strongly influence the distribution of heat, mass and momentum. Fronts and associated current systems, eddies and meanders all fall into the mesoscale category. It has been pointed out above that the temperature distributions associated with oceanic fronts exert a strong control over the locations of the sea ice margins. So, also, do the circulation features such as high-speed current jets, eddies and meanders which are frequently associated with fronts. This section describes some of these features and discusses their interactions with, and effects upon, the ice margins.

4.1 Fronts and Eddies

The sea ice margins are generally observed to be associated with frontal structures. These are regions of rapidly varying lateral gradients in properties which, in the ocean, typically include temperature, salinity and density. In addition, current speeds often vary sharply across a frontal structure, with the currents being strongly controlled by the internal density distributions associated with the front. Examples of fronts at the Greenland and Bering sea ice margins are shown in Figs. 5 and 7, respectively. It has been pointed out above that frontal temperature fields act to limit the seaward extent of the ice cover. In addition, the associated currents serve to advect ice along the margin. More importantly, lateral fluctuations in these currents can develop as meanders or eddies. The ice, which serves in most cases primarily as a passive tracer, is then advected seaward of its equilibrium location by the cross-frontal component of the fluctuating current. At this new location, melting is hastened by the warmer water seaward of the front. At the same time, the current can advect warm off-ice water beneath the ice cover and so provide heat to abet ice melting. The net effect of these transfers is to hasten melting of ice along the margin. In effect, the mesoscale fluctuations enhance lateral mixing of heat (both as warm water, and as a heat deficit in the form of sea ice) across the ice margins.

The most striking examples of mesoscale ice edge features are the circular eddies such as those which have been observed along the East Greenland Polar Front (Fig. 15). Figure 16 shows schematically how such an eddy can interact with the ice margin to produce features such as those observed. These eddies were first identified on satellite imagery, where they showed clearly along the ice edge as the ice was swept to seaward, forming a series of cusp-like features which, in some cases, curved around into full circles. They occur with great frequency along the East Greenland ice margin. They are primarily cyclonic, that is, they rotate in a counter-clockwise sense, and have diameters of order 20 km, a dimension which is typical for mesoscale eddies observed in other oceanic regions. Anticyclonic (clockwise) eddies have also been observed, but they are far fewer in number than the cyclonic variety and tend to occur farther to the west, beneath the ice cover and west of the Polar Front.

Wave-like, or meander-like, features are generally observed in conjunction with the eddies, and may occur in areas where fully developed eddies have not been observed. The East Greenland Sea ice edge reflects presence of such meanders, as well as eddies. The Labrador Sea ice edge shows, in winter, the presence of wave-like features which suggest meandering motions (LeBlond, 1982).

Wave-like or eddy features are not, however, found along all ice margins. The Bering Sea winter ice edge, for instance, reflects no such features. The summer western Arctic ice edge in the Chukchi Sea likewise shows no evidence of such phenomena. Both of these latter regions are the sites of relatively weak ice edge frontal circulation which is maintained primarily by the

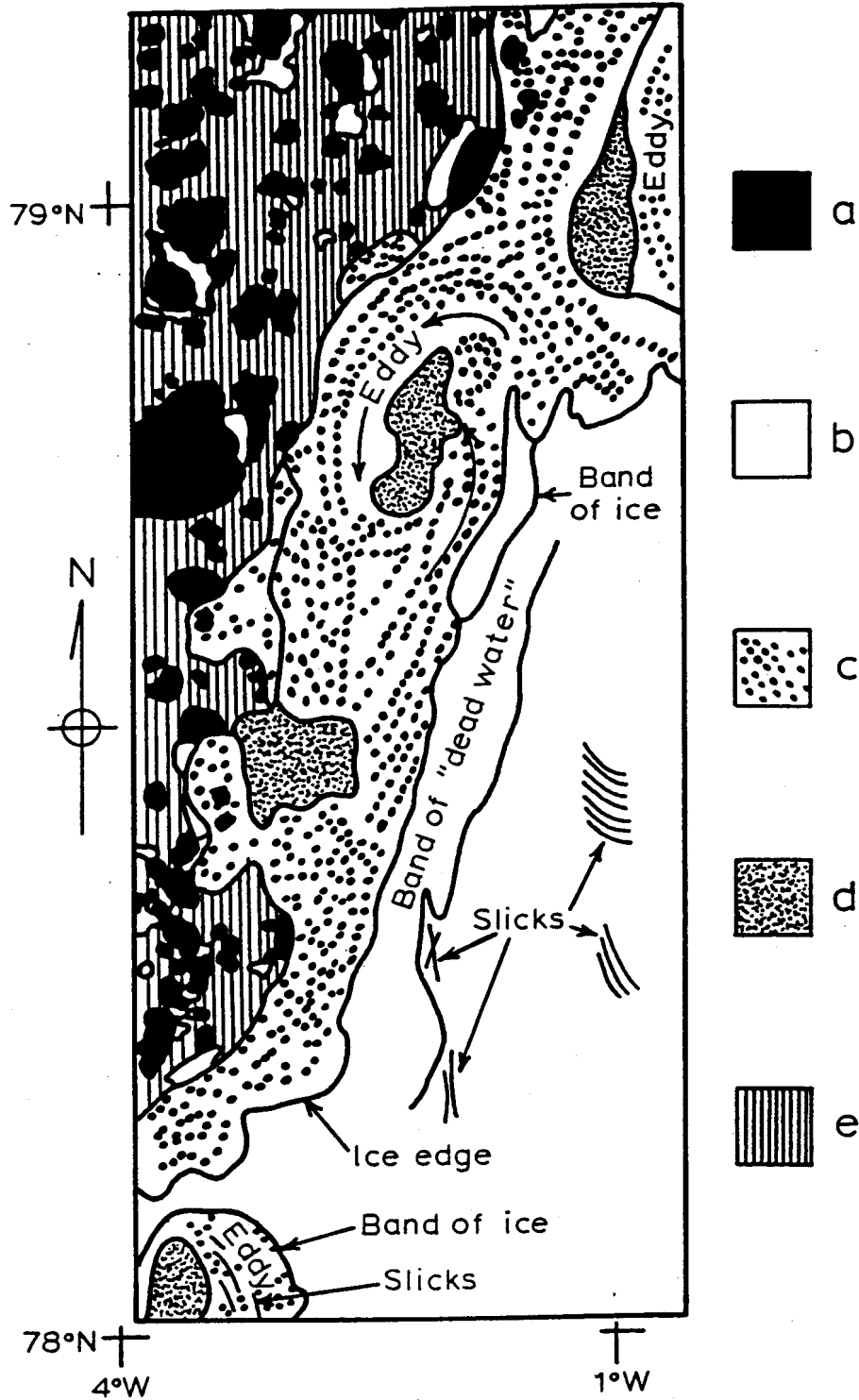

Figure 15. Schematic, derived from aircraft SAR imagery, illustrating the complex mesoscale structure present along the Greenland Sea marginal ice zone (from Johannessen *et al.*, 1987b). The features include large individual floes (a), ice-free areas (b), areas of 3/10 ice concentration and 10-500 m diameter floes (c), areas of 8/10 ice concentration and 10 m to 1.5 km diameter floes (d), and areas of 8/10 ice concentration and 10 m to 6 km diameter floes (e). Dots in areas (c) indicate locally increased ice concentration, interpreted as due to surface currents.

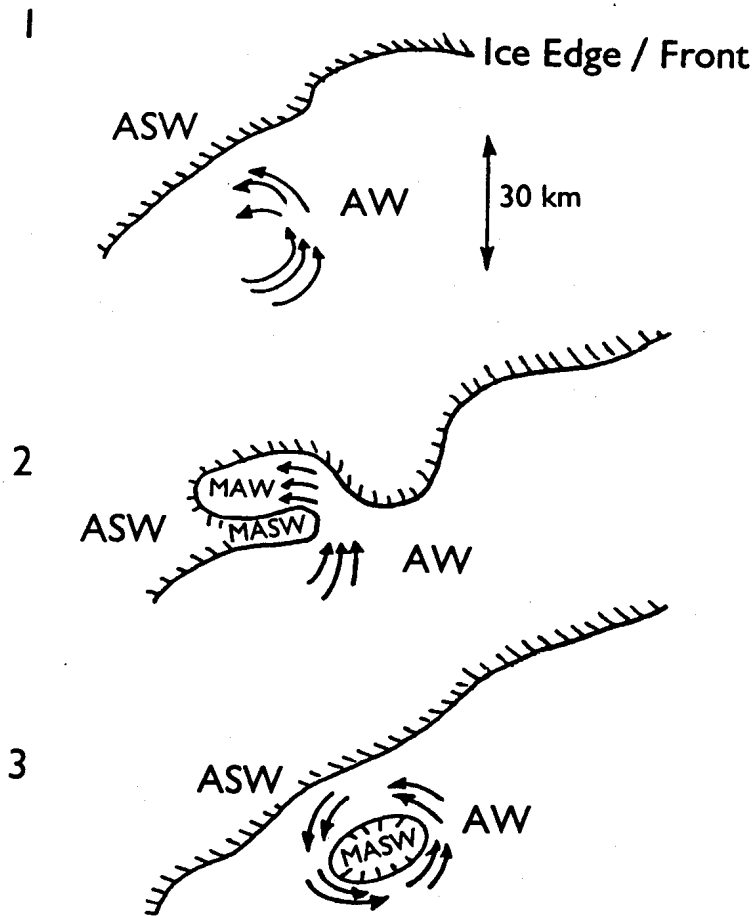

Figure 16. Schematic illustrating interaction between a cyclonic oceanic eddy and the ice edge in the Greenland Sea (from Johannessen *et al.*, 1987a). Note the modification, through lateral mixing, of Arctic Surface Water (ASW) and Atlantic Water (AW) to Modified Arctic Surface Water (MASW) and Modified Atlantic Water (MAW).

density fields set up by ice melting along the edge. In the Greenland and Labrador seas, in contrast, strong oceanic current systems are present, in association with the fronts, independently of the sea ice. These differences have a bearing on the mechanisms which lead to formation of eddies and meanders along the ice edge.

The origins of mesoscale eddies and meanders along the ice margins are uncertain; however, several hypotheses have been advanced which offer explanations for the dynamics of their formation and propagation. These hypotheses include generation by dynamic instabilities associated with the frontal currents underlying the ice margins, interactions with the bottom topography, dynamic interactions within the ice cover itself, and interactions between the ice cover and local winds. In some instances, finally, they may be formed remotely from the sea ice margins and simply be advected by the mean ocean circulation into the region. Certain of these hypotheses have greater credibility in some geographical regions than in others. Most have been

applied to the ice margin in the Greenland Sea, because eddies and meanders are such prominent features there. These possible mechanisms for eddy generation are discussed in greater detail below.

The most commonly advanced hypothesis for eddy generation is that they are due to internal dynamic instabilities within the jet-like currents associated with the ice margin frontal structures. Such instabilities effectively remove energy from the mean flow and transfer it into the fluctuations. The fluctuations then grow in magnitude at a rate determined by such factors as the vertical current shear and density stratification, the lateral current shear, and the bottom depth and slope. Starting as meanders in the current, these then grow in magnitude until they separate to become eddies. Two such instability mechanisms are possible: barotropic and baroclinic. The former derives energy for the fluctuations from the lateral shear in the mean flow. The latter derives its fluctuating energy from the potential energy contained in the baroclinic flow field, i.e., that contained in the sloping isopycnals or lines of equal density within the current system. An excellent theoretical treatment of these mechanisms is presented, for the interested reader, in Pedlosky (1982).

In the deep area in central Fram Strait, conditions are theoretically conducive to formation of such meanders and eddies (Johannessen *et al.*, 1983; 1987a). Instabilities can hypothetically form in the East Greenland Current in the northern Strait, then grow and propagate southward with the current, creating the observed interactions along the ice edge. The sense of rotation of the eddies, which tend to be cyclonic east of the Polar Front and anticyclonic west of the Front, would tend to support this mechanism, because they are properly situated relative to the lateral shear in the East Greenland Current to have these rotational tendencies. Such instabilities might also form in the north-flowing West Spitsbergen Current, to be then swept westward in the return flow and incorporated into the East Greenland Current. It has not been possible to track a single eddy for a long enough period to trace its pathway.

Recent current data from the West Greenland Current suggest that mesoscale fluctuations are advected downstream there with the same speed as the mean current (Muench *et al.*, 1986). The East Greenland Current is underlain, in this area, by a steeply sloping bottom. Steep bottom slopes tend to increase the e-folding time (i.e. slow down the growth rates) of dynamic instabilities to the point where they effectively cease to grow. In other words, a steeply sloping bottom will tend to stabilize the flow. The steep bottom slopes beneath the East Greenland Current at 79°N, coupled with the apparent passive advection of features with the mean flow, suggest that the flow is generally stable by the time the current has reached that location. If this is true, then meanders and eddies observed there were probably generated somewhere else and then advected into the region by the mean currents. This conclusion is supported by Foldvik *et al.* (1988), who conclude on the basis of lateral eddy heat flux computations that the current in

Fram Strait is dynamically stable, and by Gascard *et al.* (1987) who use ice drift data to demonstrate that the eddies in Fram Strait were probably formed elsewhere and advected into the Strait.

Internal dynamic instabilities might be abetted, in the northern Fram Strait region, by a very complex bottom topography consisting of a deep greater than 5500 m and two adjacent seamounts (Fig. 17). There appears to be a quasi-permanent eddy-like feature associated with the deep, as a result of the interactions between the current and the bottom topography (Smith *et al.*, 1984). This feature may "spin off" smaller eddies which then propagate away from the generation region, the most likely path being along the East Greenland Current. This region could, then, be a preferred region for generation of the eddies which are observed farther to the south along the ice margin.

Other sea ice margins do not appear to be sites for significant eddy generation by this mechanism. The Bering Sea winter ice margin does not exhibit mesoscale fluctuations which would suggest that such mechanisms have a significant effect there. They are, however, theoretically possible on the Bering shelf, and weak spectral peaks in winter current records from the ice margin region suggest that they may occur but are not significant relative to other processes (Muench and Schumacher, 1985). Eddies have not been observed along the summer Chukchi Sea MIZ.

It is theoretically possible for ice edge eddies to be generated through interaction between the ice edge and local winds. If the edge has pre-existing irregularities, such as a regular scallop-like pattern, then an along-ice wind will create localized, alternating regions of upwelling and downwelling along the edge which can develop into eddies like those observed (Häkkinen, 1986b). It is also possible, theoretically, for ice edge instabilities to develop, and form into eddies, through dynamics involving only the ice and the wind (Killworth and Paldor, 1985). This mechanism does not, however, allow for the effects of frictional coupling between the ice and the ocean. Neither of these hypothetical modes of eddy generation has been verified by field observations; however, either could provide a feasible explanation for the presence of mesoscale ice edge eddies in regions where they do not appear to result from dynamic oceanic instabilities.

4.2 Ice Edge Jets

Currents are frequently observed to be associated with the ice margins, and in particular in close proximity to the physical ice edge, which are stronger than elsewhere in the region. These currents typically flow parallel to the ice edge direction, and are commonly referred to as ice edge jets. These are distinct from the intensified currents which may be associated with pre-existent oceanic frontal systems at the ice margins. For instance, the high-speed core of the East Greenland Current would not be considered an ice edge jet because its presence depends on the regional oceanography rather than upon the presence of the ice edge. This feature is continuous for the length of Fram Strait, whereas ice edge jets can be discontinuous in space and time. Their

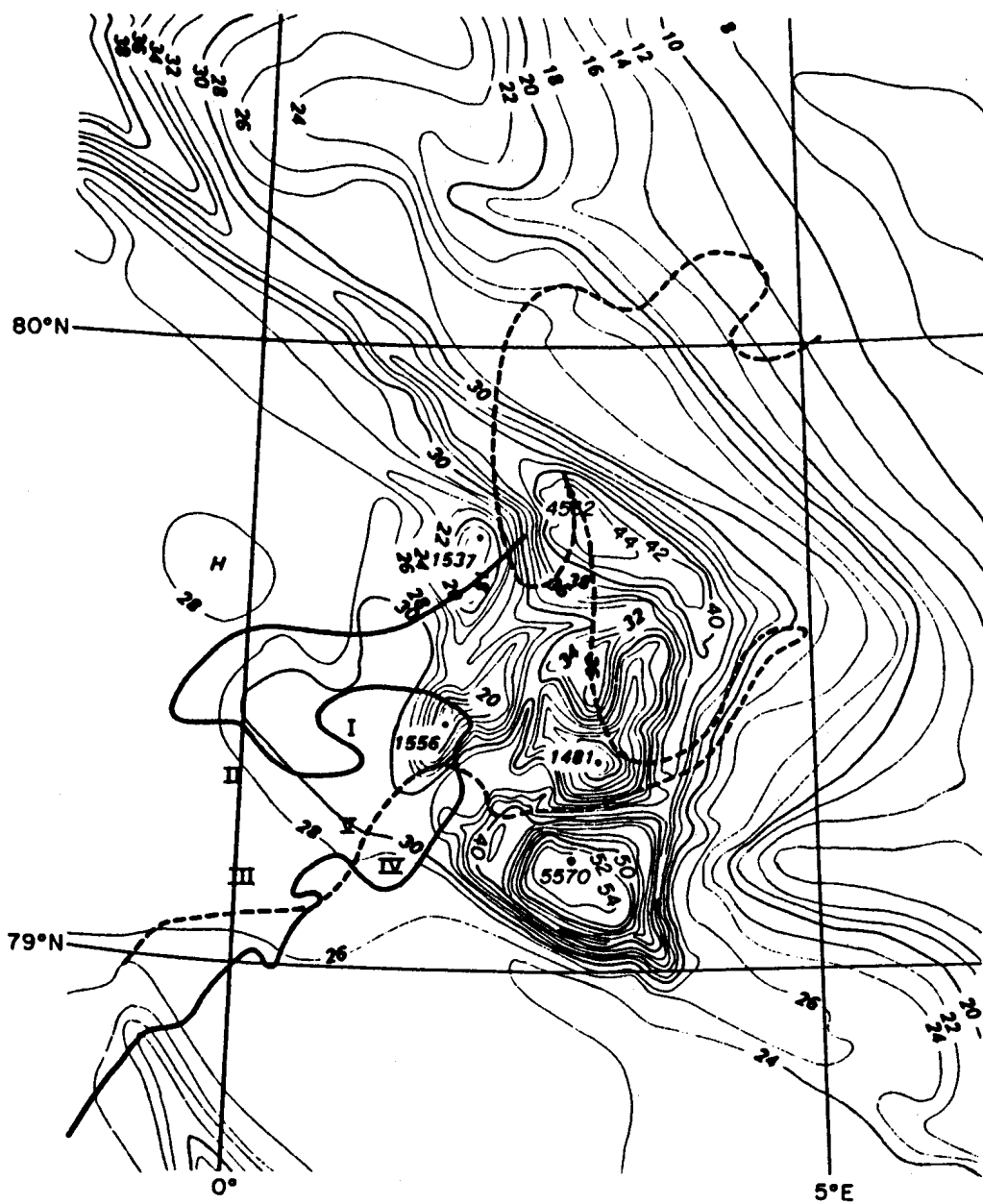

Figure 17. Schematic showing the spatial relation between complex circulation features as suggested by the ice edge at two different times (heavy solid and dashed lines) and complex bottom topography in central Fram Strait (from Smith *et al.*, 1984). Bottom depth contours are labeled in hundreds of meters.

presence depends in part upon the baroclinic, or internal density, structure induced in the upper ocean layers by meltwater along the ice edge. The structure is essentially a shallow front which underlies the ice edge and may or may not coincide with large-scale oceanic features. Surface current jets can occur where these shallow fronts intersect the sea surface. Thus, upper layer ice edge fronts, and associated current jets, along the Greenland Sea ice margin typically lie to seaward of the East Greenland Polar Front.

Ice edge current jets can form whether or not there is a pre-existing oceanic frontal structure located at the ice margin. In the Bering Sea, for example, there is a mid-winter current jet along the ice edge, toward the northwest (see Fig. 7). This feature is only present after the ice has reached its equilibrium position so that meltwater input to the ocean along the edge can generate the front and associated jet (Muench and Schumacher, 1985). The Bering Sea ice edge jet is quite continuous, and causes ice floes along the edge to advect northwestward along the edge at speeds of 10-15 cm/s, well in excess of the 2-5 cm/s mean current speeds which typify the region at other times of year. This current is sufficient to transport an appreciable volume of ice toward the northwestern Bering Sea during the course of an ice-covered season. The resulting input of low-salinity melt water to the region has not been documented, but can be expected to have an appreciable influence on local oceanographic conditions. Ice edge jets have also been observed along the midsummer ice margins in the Chukchi Sea due, again, to input of freshwater along a melting ice edge (Paquette and Bourke, 1979; 1981). These jets were not, however, as spatially or temporally continuous as that which underlay the Bering ice edge. Finally, it has been suggested on theoretical grounds that ice edge jets may form, completely independently of the underlying ocean, as a consequence of the force balances internal to the ice itself (Røed and O'Brien, 1981). These would be simply geostrophic "ice currents" balancing Coriolis force against an apparent pressure gradient generated by compressive forces within the ice.

Ice margin current jets can be subject, in themselves, to the sorts of internal oceanic instability which lead to formation of meanders and eddies as described above. Hence, the actual dynamic situation along a highly energetic ice margin, such as that in the Greenland Sea, can become exceedingly complex. This is reflected in the satellite imagery (Fig. 15). This complexity has also contributed to the difficulty of using field observations to isolate the various mechanisms for eddy and jet formation. In any given region, any of the above mechanisms might be effective, as well as additional ones which have not yet been proposed.

4.3 Ice Edge Upwelling

The ice margins present physical discontinuities, hence, also discontinuities in the coefficients which govern transfer of momentum from surface winds to the underlying ocean. The interior pack ice away from the margin, the broken, rough ice at the margin, and the open water outside the margin each present a different surface drag to the local wind field (see Overland,

1985). In general, the greatest drag is encountered at the margin where the ice is broken and aerodynamically rough. It would be expected that a discontinuity of this type, when subjected to a wind stress, would lead to regions of surface convergence (wind blowing from a region of low drag to one of high drag) or divergence (from high drag to low). In the latter case, the surface divergence must result, in order to satisfy volume continuity, in an upward flux of deeper water toward the surface. This is the "upwelling" case, where deeper water is transported upward toward the surface.

In reality, the situation is far more complex than outlined above. Typically, an ice margin will have its greatest roughness near the open water where the pack has been fractured and rafted, so that there is a transition from solid pack through a rough area to open water. A wind blowing in the "upwelling sense", i.e., along the ice edge with the ice to the left (in the northern hemisphere, to the right in the southern hemisphere) will then drive a divergent (upwelling) situation inside the rough ice cover, with a corresponding convergent (downwelling) situation at the outer ice edge. A wide range of different modes of behavior is hypothetically possible, depending upon wind direction relative to the ice margin and upon the distribution of ice roughness. Different cases have been investigated using numerical models (Røed and O'Brien, 1983; Røed, 1983).

The extent to which ice margin upwelling occurs is uncertain. Isolated events have been inferred from observations along the Greenland Sea ice margin (Buckley *et al.*, 1979) and along the Bering Sea ice margin during spring (Alexander and Niebauer, 1981). Extensive oceanographic data sets obtained at other times from sea ice margins in the Greenland, Bering and Weddell seas do not suggest, however, that it is a widespread phenomena. It is possible that the highly mobile nature of the ice cover at the margins defeats the physical mechanism, or that winds are not often sustained for a long enough period of time, properly oriented to the ice edge, to cause upwelling. It is also possible that such events, when they do occur, are masked by the other ongoing, often highly energetic phenomena such as frontal jets and eddies.

5. EFFECTS OF THE ICE MARGINS IN MODIFYING WATER MASSES

One of the major problems in large-scale oceanography remains identification and quantification of the processes which condition the mid-depth and deep waters in the major ocean basins. Specific regions of concern are the Greenland and Norwegian seas, which are the sites for formation of some of the densest deep water found in the ocean; the Arctic Ocean, because of questions surrounding the origin and maintenance of its deeper waters; and the Weddell and Ross seas for the same reasons. In order to condition water so that it can descend to great depths, it is first necessary to increase its density so that it will sink to the appropriate levels. This must take place at the sea surface through either an increase in salinity, a decrease in temperature, or both.

The first of these can be achieved through formation of ice so that the rejected brine increases ambient salinity. The second can be achieved through cooling at the surface.

The sea ice margins are sites, during winter, of active new ice formation. In the Weddell Sea, this appears to be the primary mechanism for the seasonal ice advance, with newly forming pancake ice extending for several hundred kilometers outward from the coastline during early winter. In the western Arctic, the seasonal ice advance occurs through a combination of new ice formation along the margin and southward advection of existing ice by the mean wind field. Similarly, the eastern Arctic ice advance occurs through both freezing and advection, though the ice cover in the Greenland Sea is primarily multi-year pack from the Arctic Ocean rather than being locally formed ice.

In addition to the initial major, seasonal burst of ice formation occurring in early winter, the ice margin at each of these locations advances and retreats in a pulse-wise fashion throughout the winter in response to passing storm centers. During each retreat, ice either melts or, more probably, is simply blown back by the on-ice winds to a temporary and non-equilibrium location. Following each retreat, the edge advances through seaward advection of existing ice and formation of new ice.

New ice formation is the process of particular interest, because this releases brine into the underlying water column, increasing its salinity and hence its density. If the water density is sufficiently increased, vertical convective mixing will occur, and the water column will continue to mix downward as long as the density continues to increase, with the depth determined by the ambient vertical density gradient. If continued over a long enough period, and in a region of small vertical density gradient, the convective mixing can attain great depths, and the resulting brine-enriched water can be of sufficient density to contribute to the cold, deep bottom waters found in the world ocean.

This thermohaline-driven vertical mixing can be abetted by the presence of eddies or gyres which, if they extend deeply enough, decrease the initial stability (i.e. the vertical density stratification of the water column) so that the brine-induced convection can penetrate more deeply. In a highly density stratified region such as the Bering Sea winter ice margin or the stratified frontal portion of the East Greenland Current, the density increase from brine rejection is unlikely to overcome the local stratification and allow deep convection. In areas where the ice edge extends seaward of the strong frontal structure and thus overlies water which is only weakly stratified, however, the brine-induced convection can extend to the ocean bottom. Two cases where this is suspected to occur are the East Greenland Sea winter ice edge and the Weddell Sea ice margin both at and well in from ice edge.

The process central to convective formation of deep water is believed to be development of so-called convective "chimneys", or deep-reaching cells which involve an eddy-like circulation and vertical convective mixing. Vertical convection in these cells is driven either by cooling,

brine introduced from ice formation, or both (Killworth, 1979). They may be initiated as mesoscale eddies. At the low water temperatures which characterize high latitudes, salinity exerts a much stronger control over water density than does temperature. Hence, a salinity increase due to brine introduction from freezing ice is much more effective at causing vertical convective mixing than is cooling of the sea surface. Hence, preferred locations for vertical convection are those where ice formation is occurring and where the ambient oceanic density stratification is weak. Two regions which satisfy these criteria are the winter Greenland Sea sea ice margin, which is located well east of the East Greenland Polar Front with its considerable stratification, and the greater portion of the eastern Weddell Sea from the winter sea ice margin inward for several hundred kilometers toward the Antarctic coastline. A convective chimney has been reportedly found along the winter Greenland Sea MIZ during 1987 (unpublished data from the 1987 winter Marginal Ice Zone Experiment). Gordon (1978) detected what appeared to be the summer remnant of a convective chimney which may have developed during the preceding winter (Fig. 18). The very large polynya which was observed in the eastern Weddell Sea for several winters during the late 1970's is currently believed to have resulted from convective chimneys which brought heat from deeper water to the surface and thus prevented ice formation (Parkinson, 1983).

The process of ice edge upwelling, discussed above, could abet deep water generation. This process effectively transports water from a subsurface level to the sea surface. Because of the increase in salinity with depth which occurs along virtually all of the ice margins, the water from depth is more saline than the surface water which was present prior to the upwelling event. Thus, saline water is transported to the surface where it can be cooled or have brine added through ice formation. The increase in surface salinity, through the upwelling process, preconditions the water by increasing its density prior to either cooling or freezing. Hence, a given amount of cooling or freezing will create denser water if upwelling has occurred than otherwise. The extent of this effect is uncertain, however, as the extent to which ice edge upwelling occurs is unknown.

On smaller scales, coastal polynyas may also play significant roles in the generation of oceanic deep waters. Since these polynyas are kept open not by the prevention of new ice formation, but rather by advection of new ice away from the area as it is formed, they may theoretically be the loci of considerable brine formation. The polynya south of St. Lawrence Island in the northern Bering Sea may actually see the formation during a typical winter of more than 5 m of sea ice, or far more than would form if the ice cover remained in place (Schumacher *et al.*, 1983). This has been observed to result in brine enrichment of more than 1 ppt in the water underlying the polynya. The resulting brine-enriched water mixes to the bottom, which in the northern Bering and on most continental shelf regions where such polynyas occur is quite shallow, and then flows downslope along topographic depressions in the seabed. Brine

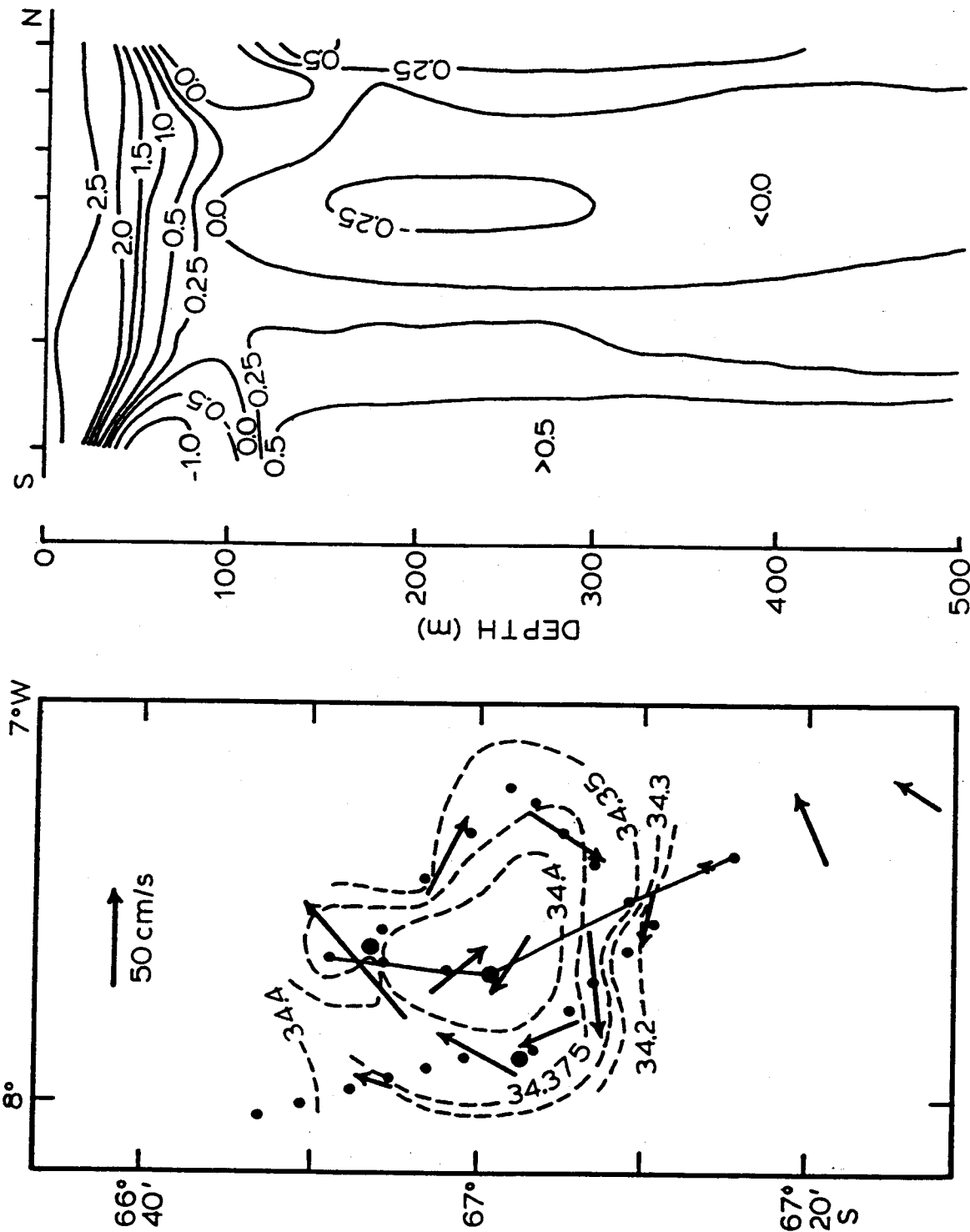

Figure 18. Left-hand frame shows surface salinity (dashed contours labeled in ppt) and currents (arrows in cm/s) associated with a remnant deep, convective feature in the eastern Weddell Sea (from Gordon, 1978). Right-hand frame shows vertical distribution of temperature (in °C) along the transect shown on the left-hand frame by the solid line. The temperature signature of the feature extended to depths of more than 4000 m.

generated in the St. Lawrence Island polynya is entrained into the northward regional flow and advected into the Arctic Ocean, where it mixes and contributes to maintenance of the mid-depth temperature-salinity structure there. Similar features along the Arctic Ocean coastline release brine which can flow directly downslope, mixing with ambient water during their downslope flow, then interleaving with Arctic Ocean waters at depths determined by their density after mixing (Aagaard *et al.*, 1981). This mechanism provides a major source for the salt needed for the mid-depth water in the Arctic Ocean basin.

As yet, direct observations of brine enrichment due to ice formation along the ice margins and in polynyas are very few. The few available observations, such as those from the St. Lawrence Island polynya, taken in conjunction with physical reasoning, suggests that such processes may be quite common and probably play a significant role in large-scale oceanic salt budgets. Convective chimneys have not yet been observed in field data, but such observations are theoretically difficult because these features are probably short-lived and relatively small in area. It has been estimated that we have only a 20% chance of observing such features (Killworth, 1979). Their feasibility depends upon physical reasoning coupled with the necessity for a viable mechanism for deep convection.

6. METEOROLOGICAL EFFECTS ASSOCIATED WITH THE ICE MARGINS

Just as the sea ice margins strongly affect the underlying ocean, they exert an influence on the overlying atmosphere. This influence is evident at scales ranging from small, such as varying surface roughness, up to effects on such regional features as storm tracks. There is an abrupt transition in virtually all physical parameters, especially temperature and roughness, in crossing the margins. These transitions lead to localized meteorological phenomena, some of which can affect the ice at the margins in a feedback mechanism.

To an observer at the ice margin, perhaps one of its most obvious characteristics is the physical roughness of the ice. The floes have been fractured, rafted, refrozen and jumbled about so that they present a considerably rougher aspect, in general, than the pack ice farther from the ice edge. This locally increased physical roughness is reflected in an increased aerodynamic roughness, which can be expressed as a drag coefficient C defined according to the relationship

$$T_a = \rho C W^2$$

where ρ is the air density, C is the drag coefficient and W is the wind speed. Sufficient observational data have been acquired to allow determination of this increase in C and to compare it with values over open water and over solid pack ice (Overland, 1985). Overland's results substantiate that the ice margins are indeed characterized by significantly greater aerodynamic roughness than occurs elsewhere over the world ocean.

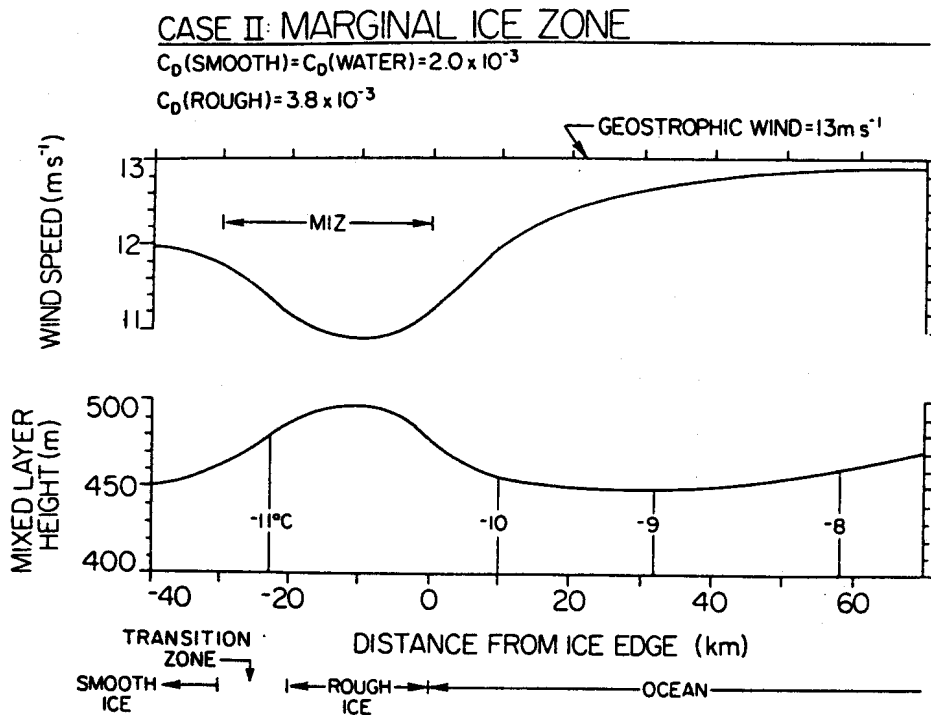

Figure 19. Dependence among wind speed, atmospheric mixed-layer height and surface roughness across the marginal ice zone, as derived from a numerical model (from Overland *et al.*, 1983).

The atmospheric boundary layer, also often referred to as the mixed layer, is modified at the ice margins by the increased surface turbulence generated by flow over the locally rough surface. In effect, the increased turbulence thickens the mixed layer and, at the same time, decreases the wind speed. Farther downstream, over the open water, the mixed layer thins and wind speeds increase. In the case where the wind is blowing seaward from the ice-covered region in winter, so that air and ice temperatures are below the freezing point for seawater, the atmospheric boundary layer is further modified by an input of heat from the open water. The transition into the region of upward heat flux can be very sudden, depending upon the sharpness of the ice edge. The increased heat flux from the open water augments the effects of increased roughness at the margin. These relationships have been successfully recreated in a mathematical model (Overland *et al.*, 1983) and are shown schematically in Fig. 19. The pattern of alternate deceleration and convergence approaching the ice margin from the ice-ward side, followed by an acceleration and divergence to seaward, would be expected to contribute to ice movements within the ice margin. Within the convergence, rafting might occur and further roughen the surface. The downwind divergence would tend to accelerate the ice seaward, contributing to a diffuse ice edge.

The sharp transition in surface temperatures between the ice and open water, particularly pronounced during winter, can produce an "ice-breeze" effect which is analogous to the sea-breeze effects which are typically encountered along temperate coastlines. The air is warmed by

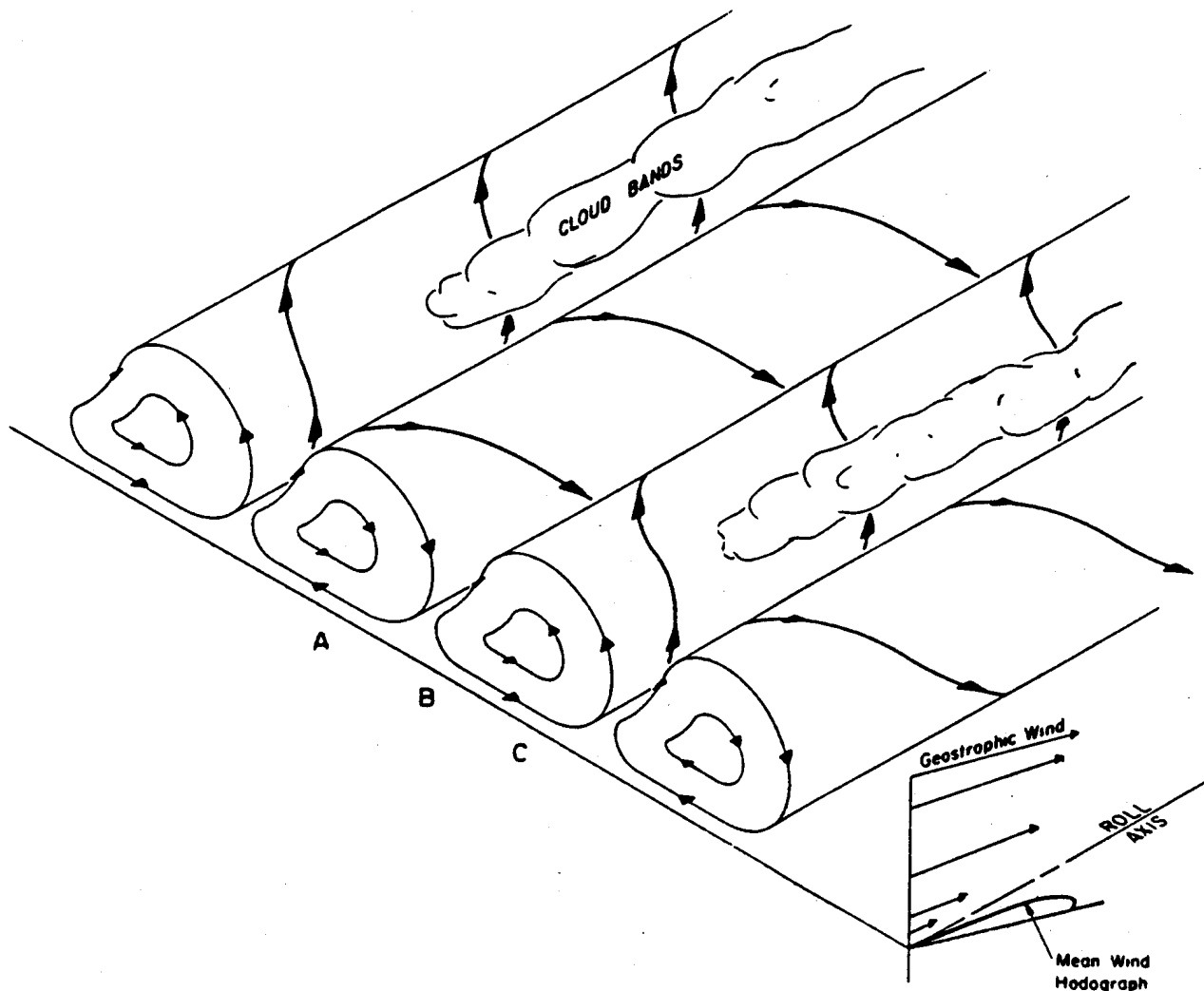

Figure 20. Schematic showing the structure of atmospheric roll vortices, accompanying cloud bands, and underlying sea ice bands which occur commonly at the ice edges when winds are seaward (off-ice) (from Brown, 1986).

heat flux from the water, rises and is replaced by a flow of air from over the ice. Because of the earth's rotation, this movement is accompanied by an airflow along the ice edge in the equatorward direction. This ice edge air circulation has been duplicated in an analytical model, which yields along-edge wind speeds exceeding 7 m/s and off-ice winds of about 3 m/s located precisely at the ice edge (Chu, 1986). The intensity of this ice edge circulation depends upon the surface temperature differential between the ice and the open water. Therefore, the effect would be greatest in winter and least during summer, when temperature differences between the ice and open water are at their smallest value during the year. The off-ice or "ice-breeze" component would contribute to a divergent, diffuse ice edge. The along-edge component would tend to drive an along-edge, jet-like ice drift.

When winds are off-ice and have speeds exceeding about 7 m/s, a secondary atmospheric circulation develops which consists of coherent, helical flow vortices which are oriented with their long axes slightly to the left of the geostrophic wind direction (Fig. 20). Along the lines of

divergence between the vortices, these result in the occurrence of cloud bands which are aligned parallel to the vortex axes. These cloud bands are ubiquitous features on satellite imagery of the sea ice margins whenever winds are off-ice and of sufficient speed. They have been successfully treated using simple models (Brown, 1986). The cross-wind circulation associated with these vortices has been observed to form surface ice into bands which are aligned along the lines of convergence at the sea surface.

As for any geophysical phenomena, an actual system will reflect presence of some or all of these processes depending upon wind speed and orientation relative to the ice edge, the character of the ice, and relative air-water and air-ice temperature differences. The height of the atmospheric mixed layer, and its stability, also play a role in developing conditions at the margin.

7. POSTSCRIPT AND ACKNOWLEDGMENTS

A great deal of new literature concerning physical phenomena in the marginal ice zones has appeared since preparation of this report in autumn of 1986. A major portion, but by no means all, of this material appeared on 30 June 1987 in a "Marginal Ice Zone Research" Special Issue of *Journal of Geophysical Research* (vol. 92, 6715-7226, 1987). Additional new research results were presented in August 1987 at the XIX General Assembly of the International Union of Geodesy and Geophysics, held in Vancouver, Canada (see the Union and IAPSO Proceedings Volumes resulting from this Assembly). Results of an austral winter 1986 field program which included the eastern Weddell Sea marginal ice zone, and of a winter 1987 program in the Greenland Sea marginal ice zone have not yet been extensively reported, but are expected to contribute significantly to our understanding of these regions.

This report has not been extensively updated to reflect the literature published since autumn 1986. The interested reader is referred to the above referenced Special Issue of the *Journal of Geophysical Research*, and to subsequent publications, for an update. New references have been added only where they substantially altered or supported the original text of the report. In point of fact, there have been only a few cases where the more recent work has demonstrably altered the conclusions presented in this report. It is hoped that this lack of need for corrections indicates that at least a few universal truths are contained herein.

This report was prepared while the author was a Visiting Scholar at Scott Polar Research Institute, Cambridge University, Cambridge, England. The support provided by the Scott Polar Research Institute and by Cambridge University is hereby acknowledged. Publication of the report has been made possible by assistance from the Marine Services Group, Pacific Environmental Laboratory of NOAA, Seattle, Washington, and is PMEL Contribution No. 1049. The work has been supported by ONR Contract N00014-82-C-0064 to Science Applications International Corporation.

8. REFERENCES

- Aagaard, K., L.K. Coachman, and E.C. Carmack, 1981: On the halocline of the Arctic Ocean. *Deep-Sea Res.*, 28, 529-546.
- Alexander, V.A. and H.J. Niebauer, 1981: Oceanography of the eastern Bering Sea ice edge zone in spring. *Limnol.-Oceanog.*, 26, 1111-1125.
- Bauer, B.J., and S. Martin, 1980: Field observations of the Bering Sea ice edge properties during March 1979. *Mon. Weather Rev.*, 108, 2045-2056.
- Bromwich, D.H. and D.D. Kurtz, 1984: Katabatic wind forcing of the Terra Nova Bay polynya. *J. Geophys. Res.*, 89, 3561-3572.
- Brown, R.A., 1986: The planetary boundary layer in the marginal ice zone. MIZEX Bull. 7, CRREL Spec. Rept. 86-3, Hanover, NH, 65-78.
- Buckley, J.R., T. Gammelsrød, J.A. Johannessen, O.M. Johannessen, and L.P. Røed, 1979: Upwelling: Oceanic structure at the edge of the Arctic ice pack in winter. *Science*, 203, 165-167.
- Chu, P.C., 1986: An ice/air feedback mechanism for the migration of the marginal ice zone. MIZEX Bull. 7, CRREL Spec. Rept. 86-3, Hanover, NH, 54-64.
- Foldvik, A., K. Aagaard, and T. Tørresen, 1988: On the velocity field of the East Greenland Current. *Deep-Sea Res.*, 35, in press.
- Gascard, J.-C., C. Kergomard, P.-F. Jeannin, and M. Fily, 1988. Diagnostic study of the Fram Strait marginal ice zone during summer from 1983 and 1984 marginal ice zone experiment Lagrangian observations. *J. Geophys. Res.*, 93, 3613-3641.
- Gordon, A.L., 1978: Deep Antarctic convection west of Maud Rise. *J. Phys. Oceanogr.*, 8, 600-612.
- Häkkinen, S., 1986a: Ice banding as a response of the coupled ice-ocean system to temporally varying winds. *J. Geophys. Res.*, 91, 5047-5053.
- Häkkinen, S., 1986b: Coupled ice-ocean dynamics in the marginal ice zones: upwelling/downwelling and eddy generation. *J. Geophys. Res.*, 91, 819-832.
- Johannessen, O.M., J.A. Johannessen, J. Morison, B.A. Farrelly, and E.A.S. Svendsen, 1983: Oceanographic conditions in the marginal ice zone north of Svalbard in early fall 1979 with an emphasis on mesoscale processes. *J. Geophys. Res.*, 88, 2755-2769.
- Johannessen, J.A., O.M. Johannessen, E. Svendsen, R. Shuchman, T. Manley, W.J. Campbell, E. Josberger, S. Sandven, J.-C. Gascard, T. Olaussen, K. Davidson, and J. Van Leer, 1987a: Mesoscale eddies in the Fram Strait marginal ice zone during the 1983 and 1984 marginal ice zone experiments. *J. Geophys. Res.*, 92, 6754-6772.
- Johannessen, O.M., J.A. Johannessen, E. Svendsen, R.A. Shuchman, W.J. Campbell, and E.G. Josberger, 1987b: Ice-edge eddies in the Fram Strait marginal ice zone. *Science*, 236, 427-429.

- Killworth, P.D., 1979: On "chimney" formation in the ocean. *J. Phys. Oceanogr.*, 9, 531-554.
- Killworth, P.D., and N. Paldor, 1985: A model of sea-ice front instabilities. *J. Geophys. Res.*, 89, 383-888.
- Lagerloef, G.S.E., and R.D. Muench, 1987: Near-inertial current oscillations in the vicinity of the Bering Sea marginal ice zone. *J. Geophys. Res.*, 92, 11789-11802.
- LeBlond, P.H., 1982: Satellite observations of Labrador Current undulations. *J. Atmos. Ocean.*, 20, 129-142.
- Lepparanta, M., W.D. Hibler, III, and O. Johannessen, 1986: On estimating ice stress from MIZEX 83 ice deformation and current measurements. MIZEX Bull. 7, CRREL Spec. Rept. 86-3, Hanover, NH, 17-19.
- Martin, S., P. Kauffman, and C. Parkinson, 1983: The movement and decay of ice edge bands in the winter Bering Sea. *J. Geophys. Res.*, 88, 2803-2812.
- McNutt, L., 1981: Ice conditions in the eastern Bering Sea from NOAA and Landsat imagery: winter conditions 1974, 1976, 1977, 1979. NOAA Tech. Memo. ERL PMEL-24, NOAA Pacific Marine Environmental Laboratory, Seattle, WA, 179 pp.
- McPhee, M.G., 1983: Turbulent heat and momentum transfer in the oceanic boundary layer under melting pack ice. *J. Geophys. Res.*, 88, 2827-2835.
- Muench, R.D., 1983: Mesoscale oceanographic features associated with the central Bering Sea ice edge: February-March 1981. *J. Geophys. Res.*, 88, 2715-2722.
- Muench, R.D., and H.E. Sadler, 1973: Physical oceanographic observations in Baffin Bay and Davis Strait. *Arctic*, 26, 73-76.
- Muench, R.D., and K. Ahlnäs, 1976: Ice movement and distribution in the Bering Sea from March to June 1974. *J. Geophys. Res.*, 81, 4467-4476.
- Muench, R.D., and R.L. Charnell, 1977: Observations of medium-scale features along the seasonal ice edge in the Bering Sea. *J. Phys. Oceanogr.*, 7, 602-606.
- Muench, R.D., P.H. LeBlond, and L.E. Hachmeister, 1983: On some possible interactions between internal waves and sea ice in the marginal ice zone. *J. Geophys. Res.*, 88, 2819-2826.
- Muench, R.D., and J.D. Schumacher, 1985: On the Bering Sea ice edge front. *J. Geophys. Res.*, 90, 3185-3197.
- Muench, R.D., G.S.E. Lagerloef, and J.T. Gunn, 1986: 1984-85 current observations in the East Greenland Current: a preliminary description. MIZEX Bull. 7, CRREL Spec. Rept. 86-3, Hanover, NH, 41-53.
- Niebauer, H.J., 1983: Multi-year sea ice variability in the eastern Bering Sea: an update. *J. Geophys. Res.*, 88, 2733-2742.
- Overland, J.E., 1985: Atmospheric boundary layer structure and drag coefficients over sea ice. *J. Geophys. Res.*, 90, 9029-9049.

- Overland, J.E., and C.H. Pease, 1982: Cyclone climatology of the Bering Sea and its relation to sea ice extent. *Mon. Weather Rev.*, 110, 5-13.
- Overland, J.E., R.M. Reynolds, and C.H. Pease, 1983: A model of the atmospheric boundary layer over the marginal ice zone. *J. Geophys. Res.*, 88, 2836-2840.
- Paquette, R.G., and R.H. Bourke, 1979: Temperature fine structure near the sea-ice margin of the Chukchi Sea. *J. Geophys. Res.*, 84, 1155-1164.
- Paquette, R.G., and R.H. Bourke, 1981: Ocean circulation and fronts as related to ice melt-back in the Chukchi Sea. *J. Geophys. Res.*, 86, 4215-4230.
- Paquette, R.G., R.H. Bourke, J.F. Newton, and W.F. Perdue, 1985: The East Greenland Polar Front in autumn. *J. Geophys. Res.*, 90, 4866-4882.
- Parkinson, C.L., 1983: On the development and cause of the Weddell Polynya in a sea ice simulation. *J. Phys. Oceanogr.*, 13, 501-511.
- Parkinson, C.L., J.C. Comiso, H.J. Zwally, D.J. Cavalieri, P. Gloersen, and W.J. Campbell, 1987: Arctic Sea Ice, 1973-1976: Satellite passive-microwave observations. NASA Rept. NASA SP-489, National Aeronautics and Space Administration, Washington, DC, 296 pp.
- Pease, C.H., 1987: The size of wind-driven coastal polynyas. *J. Geophys. Res.*, 92, 7049-7059.
- Pedlosky, J., 1982: Geophysical Fluid Dynamics. Springer-Verlag, New York.
- Røed, L.P., 1983: Sensitivity studies with a coupled ice-ocean model of the marginal ice zone. *J. Geophys. Res.*, 88, 6039-6042.
- Røed, L.P., and J.J. O'Brien, 1981: Geostrophic adjustment in highly dispersive media: an application to the marginal ice zone. *J. Geophys. Astrophys. Fluid Dyn.*, 18, 263-278.
- Røed, L.P., and J.J. O'Brien, 1983: A coupled ice-ocean model of upwelling in the marginal ice zone. *J. Geophys. Res.*, 88, 2863-2872.
- Schumacher, J.D., K. Aagaard, C.H. Pease, and R.B. Tripp, 1983: Effects of a shelf polynya on flow and water properties on the northern Bering Sea shelf. *J. Geophys. Res.*, 88, 2723-2732.
- Smith, D.C., IV, J.H. Morison, J.A. Johannessen, and O.M. Johannessen, 1984: Topographic generation of an eddy at the edge of the East Greenland Current. *J. Geophys. Res.*, 89, 8205-8208.
- Sturman, A.P., and M.R. Anderson, 1986: On the sea-ice regime of the Ross Sea, Antarctica. *J. Glaciol.*, 32, 54-59.
- Topham, D.R., R.G. Perkin, S.D. Smith, R.J. Anderson, and G. den Hartog, 1983: An investigation of a polynya in the Canadian Archipelago 1, Introduction and oceanography. *J. Geophys. Res.*, 88, 2885-2899.
- Vinje, T., and O. Finnekåsa, 1986: The ice transport through Fram Strait. *Norsk Polarinstitutt Skrifter*, 186, 39 pp.

Wadhams, P., 1983: A mechanism for the formation of ice edge bands. *J. Geophys. Res.*, 88, 2813-2818.

Zwally, H.J., J.C. Comiso, C.L. Parkinson, W.J. Campbell, F.D. Carsey, and P. Gloersen, 1983: Antarctic Sea Ice, 1973-1976: Satellite passive-microwave observations. NASA Rept. NASA SP-459, National Aeronautics and Space Administration, Washington, DC, 206 pp.